



**iPod mini**  
User's Guide

# Contents

## **3 Quick Start**

- 5 What You Need to Get Started
- 8 Setting Up iPod mini to Play Music

## **14 Using iPod mini**

- 14 Using iPod mini Controls
- 20 Connecting and Disconnecting iPod mini
- 22 Organizing and Transferring Your Music
- 28 Adjusting iPod mini Settings
- 32 Using the Extra Features of Your iPod mini
- 37 iPod mini Accessories
- 42 Charging the iPod mini Battery

## **46 Tips and Troubleshooting**

## **51 Learning More, Service, and Support**

## **53 Safety and Cleaning**

# Quick Start

Congratulations on purchasing your iPod mini. Read [this section to get started using iPod mini quickly.](#)

iPod mini works with the iTunes music software included on the iPod mini CD. Use iTunes to import songs from your CD or digital music collection to your computer, or use the iTunes Music Store (currently available only in the United States) to purchase songs and download them to your computer. Then organize the songs and transfer them to iPod mini.

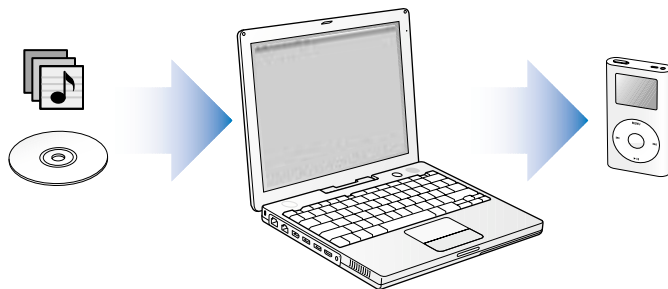

## iPod mini Features

iPod mini is a music player and much more. With iPod mini, you can:

- Store songs from your CD or digital music collection, for listening on the go
- Listen to audiobooks purchased from the iTunes Music Store (currently available only in the United States—you must have an Internet connection)
- Store and synchronize contact, calendar, and to-do list information from your computer
- Store text notes
- Set an alarm
- Play games, and more

## Learning to Use iPod mini

Read this chapter to set up iPod mini and get started playing music quickly. To learn more about playing music on iPod mini and using some of its other features, see “Using iPod mini” on page 14.

## iPod mini Tutorial

For an in-depth tutorial on transferring music to and playing music on iPod mini, see the *iPod mini Tutorial* on the iPod mini CD.

## What You Need to Get Started

To use iPod mini with a Macintosh, you must have the following:

- A Macintosh with built-in FireWire



6-pin FireWire 400 port

- Mac OS X v10.1.5 or later

Some features require Mac OS X v10.2.8 or later (Mac OS X v10.2.8 is recommended).

- iTunes 4.2 (included on the iPod mini CD) or later

To be sure you have the latest version of iTunes, go to [www.apple.com/itunes](http://www.apple.com/itunes).

- iSync 1.1 and iCal 1.0.1 or later

iSync and iCal are optional for synchronizing contact and calendar information with iPod mini. You must have Mac OS X v10.2 or later to use iSync and iCal.

**To use iPod mini with a Windows PC, you must have the following:**

- A Windows PC with 300 MHz or higher processor speed
- Windows 2000 with Service Pack 4 or later, or Windows XP Home or Professional
- iTunes 4.2 (included on the iPod mini CD) or later
- Built-in 6-pin FireWire port or a FireWire card installed, or a built-in high-power USB 2.0 port or a high-power USB 2.0 card installed



USB 2.0 port



6-pin FireWire 400 port  
(IEEE 1394)

For more information about compatible FireWire and USB cards and iPod cables, go to [www.apple.com/ipod](http://www.apple.com/ipod).

Your iPod mini includes the following components:



iPod mini

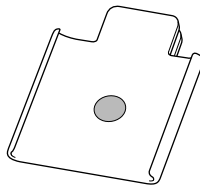

Belt Clip

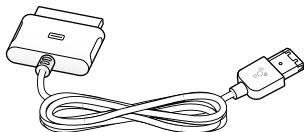

iPod Dock Connector to FireWire Cable

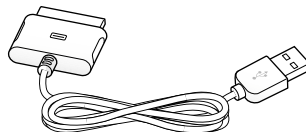

iPod Dock Connector to USB 2.0 Cable



iPod Power Adapter

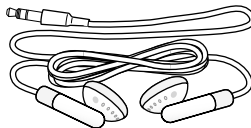

Apple Earphones

## Setting Up iPod mini to Play Music

To set up iPod mini, you charge the battery, install software from the iPod mini CD, and import songs from your music CD collection to your computer. Then you transfer the songs to iPod mini and start listening to music.

### Step 1: Charge the Battery

Connect iPod mini to the iPod Power Adapter using the iPod Dock Connector to FireWire Cable. The built-in battery is 80-percent charged in about an hour, and fully charged in about 4 hours.

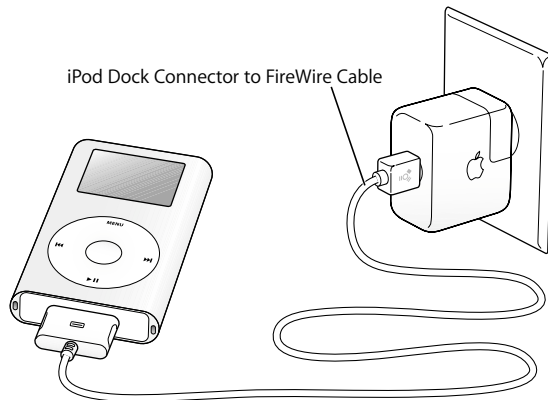

## Step 2: Install the Software

Insert the iPod mini CD into your computer and install the iPod mini and iTunes software.

## Step 3: Import Music to Your Computer

Complete this step if you haven't already transferred music to your computer. You can import music from your audio CDs, or if you have an Internet connection, you can buy music online and download it to your computer using the iTunes Music Store. You can browse hundreds of thousands of songs and listen to a 30-second preview of any song in the store. The iTunes Music Store is currently available in the United States only.

### To import music to your computer from an audio CD:

- 1 Insert a CD into your computer. iTunes opens automatically and the CD is selected in the iTunes Source list.
- 2 Uncheck songs you don't want to transfer, then click Import.
- 3 Repeat for any other CDs with songs you'd like to import.

### To buy music online (currently available in the United States only):

- 1 Open iTunes and click Music Store in the Source list.
- 2 Click the Account button and follow the onscreen instructions to set up an account or enter your existing Apple Account or America Online (AOL) account information.

For an in-depth tutorial on transferring music to and playing music on iPod mini, see the *iPod mini Tutorial* on the iPod mini CD.

#### Step 4: Connect iPod mini and Transfer Music

Connect iPod mini to your computer using one of the two included cables. Be sure the connectors on both ends of the cable are oriented correctly. They can only be inserted one way.

*If you have a Mac, or if you have a Windows PC with a 6-pin FireWire 400 port, use the iPod Dock Connector to FireWire Cable.*

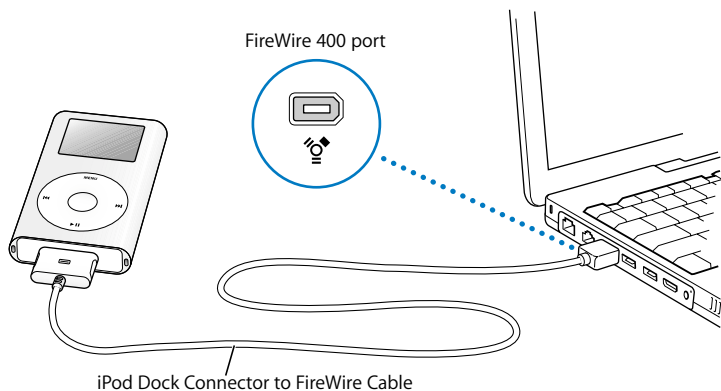

If you have a Windows PC that doesn't have a FireWire port, but has a high-power USB 2.0 port, use the iPod Dock Connector to USB 2.0 Cable.

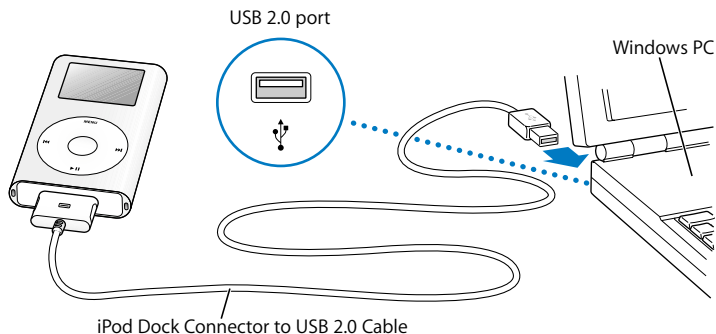

**Note:** Be sure to connect iPod mini to a USB 2.0 port directly on your computer, or to a powered USB 2.0 hub that's connected to your computer. iPod mini won't work if it's connected to a low-power USB 2.0 port, such as those sometimes found on keyboards or other peripherals.

**Note:** If you're using a Windows PC laptop computer with a high-power USB 2.0 port, connect the computer to a power outlet before connecting iPod mini for best results.

When you connect iPod mini to your computer, iTunes opens automatically and transfers the songs and playlists in your music library to iPod mini.

When the transfer is complete, a message on the iPod mini screen says "OK to disconnect," or you see the main menu.

*If your Windows PC doesn't have a FireWire port or a USB 2.0 port, you can purchase a FireWire card or USB 2.0 card, and install it.*

For more information on cables and compatible FireWire and USB cards, go to [www.apple.com/ipod](http://www.apple.com/ipod).

### **Step 5: Play Music**

When the song transfer is complete, disconnect iPod mini from your computer. Use the Click Wheel and Select button to browse for a song. Then press the Play or Select button and enjoy!

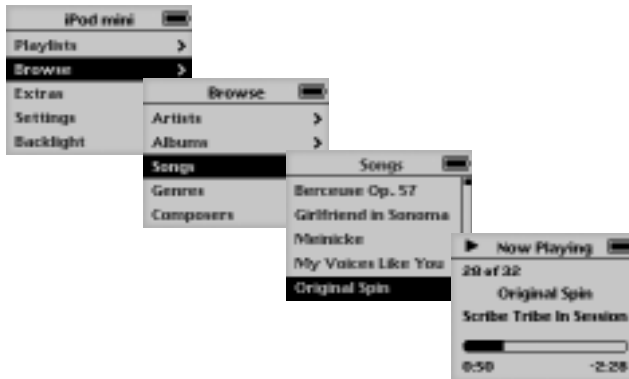

## To Learn More

Read the next chapter to learn more about using the Click Wheel and the other iPod mini controls, transferring music to and managing music on iPod mini, using other features of iPod mini, charging the battery, and using iPod accessories.

# Using iPod mini

Read this section to learn about using iPod mini controls, transferring music, charging the battery, and using the extra features of your iPod mini.

## Using iPod mini Controls

Press the Select button (in the center of iPod mini) to turn on iPod mini. The main menu appears.



Use the Click Wheel and Select button to navigate through onscreen menus, play songs, change settings, and view information. Move your thumb lightly around the Click Wheel to scroll to a menu item. Press the Select button to select the item. Press Menu on the Click Wheel to go back to the previous menu.

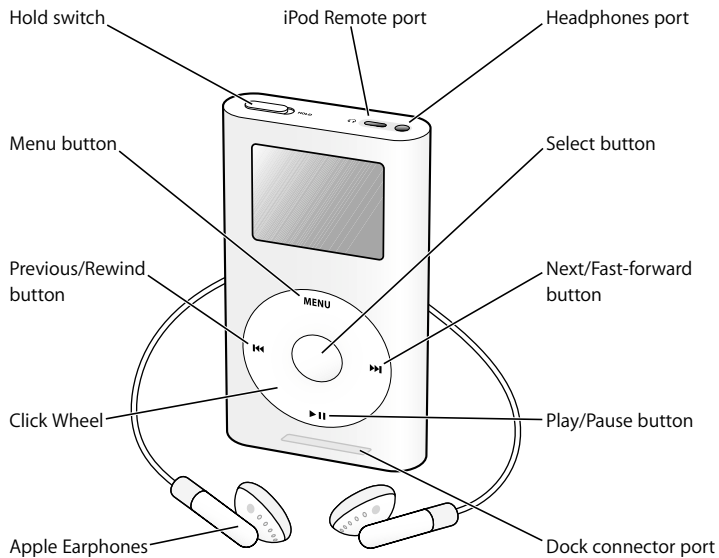

## iPod mini Controls

<b>Reset iPod mini</b> (For use during troubleshooting)	Toggle the Hold switch (set it to hold, then turn it off again). Then press the Menu and Select buttons simultaneously for about 6 seconds, until the Apple logo appears.
<b>Turn iPod mini on</b>	Press the Select button.
<b>Turn iPod mini off</b>	Press and hold Play/Pause.
<b>Turn the backlight on or off</b>	Press and hold Menu or select Backlight from the main menu.
<b>Select a menu item</b>	Scroll to the item and press the Select button.
<b>Go back to the previous menu</b>	Press Menu.
<b>Browse for a song</b>	Select Playlists or Browse from the main menu.
<b>Play a song</b>	Highlight the song and press the Select or Play/Pause button.
<b>Play all the songs in a list</b>	Highlight the list title (an album title, or the title of a playlist, for example) and press Play/Pause.
<b>Change the volume</b>	From the Now Playing screen, use the Click Wheel. You can also use the optional iPod Remote (available at <a href="http://www.apple.com/store">www.apple.com/store</a> ) from any screen.
<b>Pause a song</b>	Press Play/Pause when no song or list is highlighted.
<b>Disable iPod mini controls</b> (So you don't press them accidentally)	Set the Hold switch to hold (an orange bar appears).

## iPod mini Controls

<b>Skip to any point in a song</b>	From the Now Playing screen, press the Select button. Then scroll to any point in the song.
<b>Skip to the next song</b>	Press Next/Fast-forward.
<b>Start a song over</b>	Press Previous/Rewind.
<b>Play the previous song</b>	Press Previous/Rewind twice.
<b>Fast-forward</b>	Press and hold Next/Fast-forward.
<b>Rewind</b>	Press and hold Previous/Rewind.

## Disabling iPod mini Buttons Using the Hold Switch

If you're carrying iPod mini in your pocket and you don't want to activate the controls or turn it on accidentally, you can make the controls inactive.

- Set the Hold switch to hold.

Slide the switch toward the center (so you can see the orange stripe) to disable the controls.

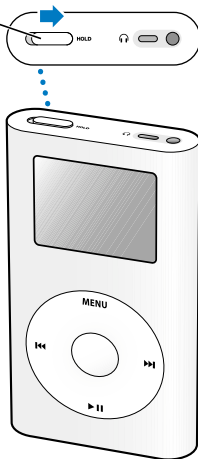

## Queueing Up a List of Songs

You can set iPod mini to play the songs you want in the order you want. When you create a list of songs on your iPod mini, the songs appear in an On-The-Go playlist.

### To create an On-The-Go playlist:

- 1 Highlight a song and press and hold the Select button until the song title flashes.
- 2 Repeat step 1 for other songs you want to add.
- 3 Select Playlists > On-The-Go to view your list of songs.

You can also queue entire lists of songs. For example, to queue an album, highlight the album title and press and hold the Select button until the album title flashes.

### To play songs in the On-The-Go playlist:

- Select Playlists > On-The-Go and select a song.

### To clear the On-The-Go playlist:

- Select Playlists > On-The-Go > Clear Playlist.

### To transfer On-The-Go playlists to your computer:

- If iPod mini is set to transfer songs automatically (see page 25), and you create an On-The-Go playlist, the playlist automatically transfers to iTunes when you connect iPod mini. You see the new On-The-Go playlist in the iTunes Source list.

## Rating Songs

You can assign a rating to a song (from 1 to 5 stars) to indicate how much you like it.

You can use song ratings to help you create playlists automatically in iTunes (see “About Smart Playlists” on page 25).

**To rate a song:**

- 1 Start playing the song.
- 2 From the Now Playing screen, press the Select button twice.
- 3 Use the Click Wheel to select a rating.

## Connecting and Disconnecting iPod mini

You connect iPod mini to your computer to transfer and manage music, and in most cases, to charge the battery. If you have a Mac, you connect iPod mini using the included FireWire cable. If you have a Windows PC, use the FireWire or the USB 2.0 cable, depending on which port your computer has (see page 10 for illustrations and more information).

**To connect iPod mini to your computer:**

- Plug the cable in to a FireWire or high-power USB 2.0 port on your computer, then connect the other end to iPod mini. Be sure to orient the connectors on both ends of the cable correctly. Each connector can only be inserted one way.
- Or, if you have an optional iPod mini Dock (see page 38), connect the cable to a FireWire or high-power USB 2.0 port on your computer and connect the other end to the Dock. Then put iPod mini in the Dock. The iPod mini Dock is available at [www.apple.com/store](http://www.apple.com/store).

By default, iPod mini imports songs automatically when you connect it to your computer. When this automatic transfer is done, it's OK to disconnect iPod mini.

## Disconnecting iPod mini

If you set iPod mini to transfer songs manually (see page 26) or enable iPod mini for use as a hard disk (see page 32), you must eject iPod mini before disconnecting it.

If it is not OK to disconnect iPod mini, this screen appears:



**Important:** Don't disconnect iPod mini if you see the "Do not disconnect" message. You could damage files on iPod mini. If you see this message, you must eject iPod mini before disconnecting it.

### To eject iPod mini:

- Select iPod mini in the iTunes Source list and click the Eject button.



*If you're using a Mac, you can also eject iPod mini by dragging the iPod mini icon on the desktop to the Trash.*

*If you're using a Windows PC, you can eject iPod mini by clicking the Safely Remove Hardware icon in the Windows system tray and selecting your iPod mini.*

If it is OK to disconnect iPod mini from your computer, this screen appears:



Or, a large battery icon appears:



## Organizing and Transferring Your Music

For instructions for getting started playing music on iPod mini, see “Setting Up iPod mini to Play Music” on page 8. Read on for more information about organizing and transferring your music.

### About iTunes

iTunes is the software application you use to manage the music on your computer and transfer music to iPod mini. When you connect iPod mini to your computer, iTunes opens automatically.



Here are some of the things you can do with iTunes:

- Purchase and download songs from the iTunes Music Store (currently available in the United States only)
- Listen to CDs and digital music
- Add music from CDs to your music library, so you don't need to have the CD in the drive to play music
- Organize songs into playlists you create
- Make your own CDs (if your computer has a CD-RW drive)
- Listen to Internet radio stations

This booklet explains how to transfer songs to iPod mini using iTunes and manage songs on iPod mini. For information about using the other features of iTunes, open iTunes and choose Help > iTunes and Music Store Help.

### About the iTunes Music Store

Using iTunes 4.2, you can preview, purchase, and download your favorite songs from the iTunes Music Store (currently available in the United States only). There are hundreds of thousands of songs available. You can use an Apple Account to sign on to the music store, or if you have an America Online (AOL) account, you can use that.

#### To browse for and purchase music:

- 1 Open iTunes and click Music Store in the Source list.
- 2 Click the Account button and follow the onscreen instructions to set up an account or enter your existing Apple Account or AOL account information.

For more information, open iTunes and choose Help > iTunes and Music Store Help.

## Audio File Formats Supported by iPod mini

- AAC (M4A, M4B, M4P) (up to 320 KB/s)
- MP3 (up to 320 KB/s)
- MP3 Variable Bit Rate (VBR)
- WAV
- AA (Audible spoken word)
- AIFF (Macintosh only)

A song encoded in AIFF or WAV format takes up more space than the same song encoded in AAC or MP3 format. When you import music from a CD using iTunes, it is converted to AAC format by default.

iPod mini does not support MPEG Layer 1 or MPEG Layer 2 audio files.

## About Playlists

Using iTunes, you can organize songs into playlists. For example, you can create a playlist with songs to listen to while exercising or with songs for a particular mood.

You can create as many playlists as you like using any of the songs in your computer's music library. Putting a song in a playlist doesn't remove it from the library.

When you connect and update iPod mini, the playlists are transferred to iPod mini. To browse through playlists, select Playlists in the iPod mini main menu.

## About Smart Playlists

Using iTunes, you can automatically create customized Smart Playlists from the songs in your library. You can create a Smart Playlist that includes only certain genres of music, songs by certain artists, or songs that match particular criteria. For example, you could create a playlist that's no more than 3 gigabytes (GB) in size and includes only songs you have rated 3 stars or higher (see "Rating Songs" on page 19).

After you create a Smart Playlist, any songs on iPod mini that meet the Smart Playlist's criteria are automatically added to the Smart Playlist.

## Creating Playlists on Your Computer

### To create a playlist:

- In iTunes, click the Add (+) button and type a name for the playlist, then drag songs from the library or another playlist to the new playlist.

### To create a Smart Playlist:

- In iTunes, choose File > New Smart Playlist and choose the criteria for your playlist. Any songs from your library that match the criteria you choose are automatically added to the playlist.

## Transferring Songs and Playlists to iPod mini Automatically

By default, iPod mini updates automatically when you connect it to your computer. iTunes updates the iPod mini music library to match the songs and playlists in your computer's music library, transferring new songs to iPod mini and deleting songs from iPod mini that aren't in your music library.

You can set iPod mini to transfer only certain songs in the iTunes library. This is useful if you have more music on your computer than will fit on your iPod mini.

### To update iPod mini with only certain songs:

- 1 In iTunes, check the boxes next to songs you want to transfer (by default, all songs are checked).
- 2 Select iPod mini in the Source list and click the Options button.



Options button

- 3 Select “Only update checked songs.”

### To set iPod mini to update only selected playlists:

- 1 In iTunes, select iPod mini in the Source list and click the Options button.



Options button

- 2 Select “Automatically update selected playlists only.”

## Transferring Songs and Playlists to iPod mini Manually

You can set iPod mini to transfer songs manually, so you can transfer individual songs and playlists.

When iPod mini is set to transfer songs manually, it doesn't synchronize automatically when you connect it to your computer.

### To set iPod mini to transfer songs manually:

- 1 In iTunes, select iPod mini in the Source list and click the Options button.



Options button

- 2 Select “Manually manage songs and playlists.”

### To transfer a song or playlist to iPod mini manually:

- In iTunes, drag a song or playlist to iPod mini in the Source list.

### Deleting Songs and Playlists From iPod mini Manually

If you have set iPod mini to transfer songs manually (see above), you can delete songs and playlists from iPod mini individually. Songs deleted from iPod mini manually are not deleted from the iTunes library.

### To delete a song or playlist from iPod mini:

- 1 Select iPod mini in the iTunes Source list.
- 2 Select a song or playlist and press the Delete key on the keyboard.  
If you delete a playlist, the songs in the playlist remain on iPod mini.

### Modifying Playlists on iPod mini Manually

If you have set iPod mini to transfer songs manually (see above), you can create new playlists on iPod mini, and add songs to or delete songs from playlists already on iPod mini.

### **To create a new playlist on iPod mini:**

- 1 Select iPod mini in the iTunes Source list and click the Add (+) button.
- 2 Drag songs to the new playlist.

### **To modify a playlist on iPod mini:**

- Drag a song to a playlist on iPod mini to add the song. Select a song in a playlist and press the Delete key on your keyboard to delete the song.

## **Listening to Spoken Word Audio**

You can purchase and download spoken word audiobooks from the iTunes Music Store (currently available only in the United States) and listen to them on your iPod mini.

You can use iTunes to transfer audiobooks to your iPod mini the same way you transfer songs.

If you stop listening to an audiobook on iPod mini and go back to it later, the audiobook begins playing from where you left off.

## **Seeing How Many Songs Are on iPod mini**

To see how many songs are stored on iPod mini, how much disk space is left, and other information, select Settings > About.

## **Adjusting iPod mini Settings**

You can change settings directly on iPod mini in the Settings menu.

## **Setting iPod mini to Shuffle or Repeat Songs**

You can set iPod mini to repeat a song over and over, or to repeat a sequence of songs. You can also set it to shuffle (play songs or albums in random order).

iPod mini repeats or shuffles songs within the list (album or playlist, for example) from which the first song was selected.

**To set iPod mini to repeat songs:**

- Select Settings from the iPod mini main menu.
  - *To repeat all songs in the list*, set Repeat to All.
  - *To repeat one song over and over*, set Repeat to One.

**To set iPod mini to shuffle songs or albums:**

- 1 Select Settings from the iPod mini main menu.
- 2 Set Shuffle to Songs or to Albums.

When you set iPod mini to shuffle albums, it plays all the songs on an album in order, then randomly selects another album and plays through it in order.

When set to shuffle, iPod mini won't repeat a song or album until it has played through the entire list from which the first song or album was selected.

### Setting Songs to Play at the Same Relative Volume Level

iTunes can automatically adjust the volume of songs, so they play at the same relative volume level. You can set iPod mini to use the iTunes volume settings.

**To set iTunes to adjust all songs to play at the same relative sound level:**

- 1 In iTunes, choose iTunes > Preferences if you are using a Mac, or choose Edit > Preferences if you are using a Windows PC.
- 2 Click Effects and select Sound Check.

### **To set iPod mini to use the iTunes volume settings:**

- Select Settings > Sound Check.

If you have not activated Sound Check in iTunes, setting it on iPod mini has no effect.

### **Using the iPod mini Equalizer**

You can use equalizer presets to change iPod mini sound to suit a particular music genre or style. For example, to make rock music sound better, set the equalizer to Rock.

- Select Settings > EQ and select an equalizer preset.

### **Setting the Backlight Timer**

You can set the backlight to turn on for a certain amount of time when you press a button or use the Click Wheel.

- Select Settings > Backlight Timer and select the time you want.

Even if you don't set the backlight timer, you can turn on the backlight at any time by pressing and holding Menu on the iPod mini Click Wheel or selecting Backlight from the main menu. After a few seconds, the backlight turns off.

### **Setting the Screen Contrast**

- 1 Select Settings > Contrast.
- 2 Use the Click Wheel to adjust the contrast.

If you accidentally set the screen contrast too light or too dark, you can reset it to the default by pressing and holding Menu on the Click Wheel for about 4 seconds.

## Adding or Removing Items From the Main Menu

You can add often-used items to the iPod mini main menu. For example, you can add a “Songs” item to the main menu, so you don’t have to select Browse before you select Songs.

**To add or remove items from the main menu:**

- Select Settings > Main Menu.

## Setting and Viewing Date and Time

**To set the date and time:**

- Select Settings > Date & Time.

**To view the date and time:**

- Select Extras > Clock.

**To set iPod mini to display the time in the title bar:**

- Select Settings > Date & Time.

If you set iPod mini to display the time in the title bar, you can see the time from any iPod mini menu screen.

## Setting the Language

iPod mini can be set to use different languages.

- Select Settings > Language and select a language.

If you accidentally set iPod mini to use a language you don’t understand, you can reset the language.

- 1 Press Menu repeatedly until the main menu appears.
- 2 Select the fourth menu item (Settings).

- 3 Select the last menu item (Reset All Settings).
- 4 Select the second menu item (Reset) and select a language.

Other iPod mini settings, such as song repeat, are also reset.

**Note:** If you have added or removed items from your main menu (see page 31), the Settings menu may be in a different place.

## Using the Extra Features of Your iPod mini

### Using iPod mini as an External Hard Disk

You can use iPod mini as a hard disk, to store and transfer data files.

**To enable iPod mini as a hard disk:**

- 1 In iTunes, select iPod mini in the Source list and click the Options button.



Options button

- 2 Select "Enable disk use."

When you use iPod mini as a hard disk, the iPod mini disk icon appears on the desktop on the Mac, or as the next available drive letter in Windows Explorer on a Windows PC.

**Note:** Selecting "Manually manage songs and playlists" in the Options window also enables iPod mini to be used as a hard disk.

**Note:** To transfer songs to iPod mini for playing, you must use iTunes. Songs transferred via iTunes do not appear on iPod mini in the Macintosh Finder or Windows Explorer. Likewise, if you copy music files to iPod mini in the Macintosh Finder or Windows Explorer, you won't be able to play them on iPod mini.

## Preventing iTunes From Opening Automatically

If you use iPod mini primarily as a hard disk, you may want to disable iTunes from opening automatically when you connect iPod mini to your computer.

**To prevent iTunes from opening automatically when you connect iPod mini to your computer:**

- 1 In iTunes, select iPod mini in the Source list.
- 2 Click the Options button and deselect "Open iTunes when attached."



Options button

## Setting the Sleep Timer

You can set iPod mini to turn off automatically after a specific period of time.

- Select Extras > Clock > Sleep Timer and select the time you want.

When you set the sleep timer, a clock icon and the number of minutes left until iPod mini turns off appear in the Now Playing screen on iPod mini.

## Setting the Alarm

You can use iPod mini as an alarm clock.

### To set an alarm:

- 1 Select Extras > Clock > Alarm Clock.
- 2 Set Alarm to On.
- 3 Select a sound.

If you select Beep, the alarm will be audible through the internal speaker. If you select a playlist, you'll need to connect iPod mini to speakers or headphones to hear the alarm.

## Importing Addresses, Phone Numbers, Calendar Events, and To-Do Lists

Your iPod mini can store contacts, calendar events, and to-do lists, for viewing on the go. If you are using a Mac and iSync, it's as easy as clicking a button.

### To import all information using a Mac and iSync:

- 1 Connect iPod mini to your computer.
- 2 Open iSync and choose Devices > Add Device. You only need to do this step the first time you use iSync with your iPod mini.
- 3 Select iPod mini and click Sync Now.

The next time you want to sync iPod mini, you can simply open iSync and click Sync Now. You can also choose to have iPod mini sync automatically when you connect it.

iSync imports information from iCal and Mac OS X Address Book.

**Note:** iSync transfers information from your computer to your iPod mini. You can't use iSync to transfer information from your iPod mini to your computer.

If you are using Windows, or you don't want to import using iSync, you can transfer information to iPod mini manually. iPod mini must be enabled as a hard disk (see "Using iPod mini as an External Hard Disk" on page 32).

**To import contact information manually:**

- 1 Connect iPod mini to your computer and open your favorite email or contacts application. Importing contacts works with Palm Desktop, Microsoft Outlook, Microsoft Entourage, and Eudora, among others.
- 2 Export contacts as vCard files and copy them to the Contacts folder on iPod mini. To do so, drag contacts from the application's address book to the iPod mini Contacts folder.

**To import appointments and other calendar events manually:**

- 1 Export calendar events from any calendar application that uses the standard iCalendar format (filenames end in .ics) or vCal format (filenames end in .vcs).
- 2 Drag the files to the Calendars folder on iPod mini.

**Note:** You can only view to-do lists on iPod mini using iSync and iCal.

**To view contacts on iPod mini:**

- Select Extras > Contacts.

**To view calendar events:**

- Select Extras > Calendar.

**To view to-do lists:**

- Select Extras > Calendar > To Do.

## Storing and Reading Notes and Other Information

You can store and read text notes on iPod mini. iPod mini must be enabled as a hard disk (see page 32).

**To store notes on iPod mini:**

- 1 Save a document in any word-processing application as a text (.txt) file.
- 2 Place the file in the Notes folder on iPod mini.

**To view notes:**

- Select Extras > Notes.

## Playing Games

iPod mini has a number of games.

- To play a game, select Extras > Games and select a game.

## iPod mini Accessories

iPod mini comes with some accessories, and many other accessories are available at [www.apple.com/store](http://www.apple.com/store).

### Apple Earphones

iPod mini comes with a pair of high-quality earbud headphones.

#### To use the earbud headphones:

- Plug them in to the Headphones port, then place the earbud in your ear as shown.



**Warning** Listening to music at high volume over extended periods of time can damage your hearing.

## iPod mini Dock (Available Separately)

The iPod mini Dock holds iPod mini upright as it charges or transfers music. Connect the Dock to your computer using the same cable you use with iPod mini, or connect it to a power outlet using the FireWire cable and power adapter. Then put iPod mini in the Dock.

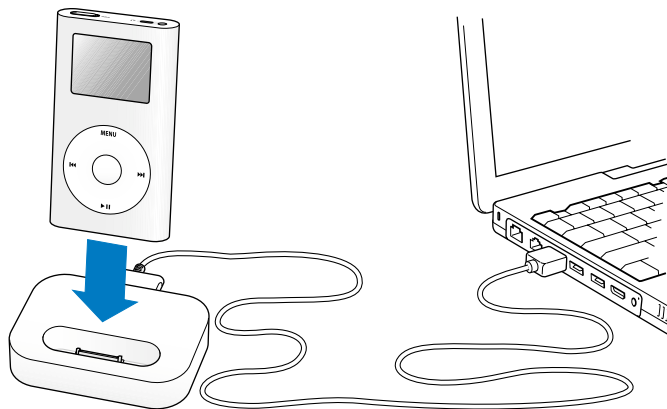

**Note:** Be sure the connectors on the cable are oriented correctly. Each connector can only be inserted one way. Your computer must be on and not in sleep mode (some models of Macintosh can be in sleep mode and charge the battery).

Using the iPod mini Dock, you can play music from iPod mini over external powered speakers or a home stereo. You need an audio cable with a standard 3.5 millimeter stereo miniplug (many external speakers have this type of cable attached).

**To play music from iPod mini using the Dock:**

- 1 Place iPod mini in the Dock.
- 2 Connect the speakers or stereo to the Dock Line Out port.

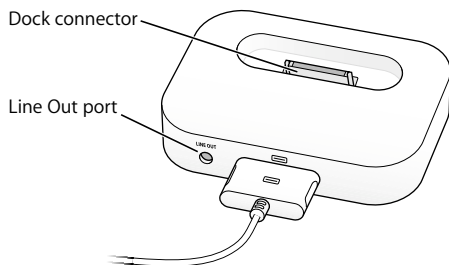

- 3 Use the iPod mini controls to play a song.  
When the Dock is connected to an external audio source, use the volume controls on the external source to change the volume.

## iPod mini Belt Clip

iPod mini comes with a handy belt clip. To use the belt clip, snap iPod mini into the casing, then attach the clip to your belt or another piece of clothing.

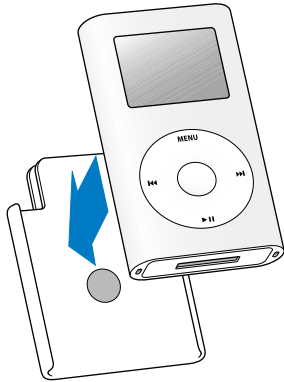

Snap the iPod mini into the belt clip.

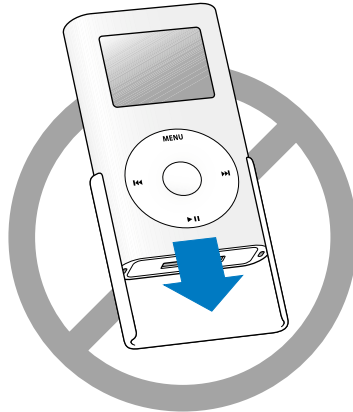

Do not slide the iPod mini into the belt clip.

### iPod Remote (Available Separately)

With the iPod Remote, you can control iPod mini while it is in your pocket. To use the iPod Remote, connect it to the iPod Remote port, then connect the Apple Earphones (or another set of headphones) to the remote. Use the buttons on the remote just as you would use the iPod mini buttons.

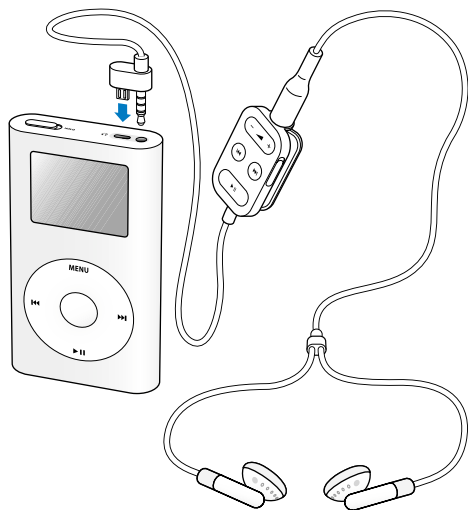

Use the remote's Hold switch to disable the remote's buttons. The iPod mini Hold switch and the iPod Remote Hold switch do not affect one another.

## Available Accessories

To purchase iPod mini accessories, go to [www.apple.com/store](http://www.apple.com/store).

Available accessories include:

- iPod mini Dock
- iPod mini Armband
- iPod Remote + Earphones
- iPod In-Ear Headphones
- iPod Dock Connector to FireWire Cable
- iPod Power Adapter
- World Travel Adapter Kit
- Third-party accessories such as speakers, headsets, backup batteries, car stereo adapters, power adapters, and more

## Charging the iPod mini Battery

The iPod mini battery is 80-percent charged in about an hour, and fully charged in about 4 hours. If you charge iPod mini while transferring files or playing music, it may take longer.

iPod mini has an internal, nonremovable battery. If iPod mini isn't used for a while, the battery may need to be charged.

**You can charge the iPod mini battery in two ways:**

- If you have a Mac, you can charge iPod mini by connecting it to your computer. If you have a Windows PC with a 6-pin FireWire port or a high-power USB 2.0 port, in most cases you can charge iPod mini by connecting it to your computer.
- You can also charge iPod mini by connecting it to the power adapter and a working electrical outlet.

**To charge the iPod mini battery using your computer:**

- Connect iPod mini to your computer using the included FireWire cable or USB 2.0 cable. The computer must be turned on and not in sleep mode (some models of Macintosh can charge iPod mini while in sleep mode).

If the battery icon in the top-right corner of the screen shows a lightning bolt, the battery is charging.



If you don't see the lightning bolt, you must charge the battery using the iPod Power Adapter (see below).

**To charge the iPod mini battery using the iPod Power Adapter:**

- 1 Connect the AC plug adapter to the power adapter (this may already be assembled).
- 2 Connect the FireWire cable to the power adapter, and plug the other end of the cable in to iPod mini.
- 3 Plug the power adapter in to a working electrical outlet.

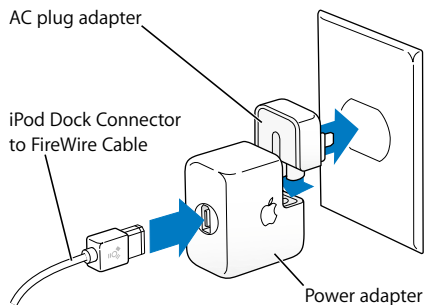

**Warning** Make sure the power adapter is fully assembled before plugging it in to an electrical outlet.

## Battery States

When iPod mini is not connected to a power source, a battery icon in the top-right corner of the screen shows about how much charge is left.



Battery about  
halfway charged

If iPod mini is connected to a power source, the battery icon animates to show that the battery is charging.



Battery charging

If you connect iPod mini to a power source and the battery icon does not animate, the battery is fully charged.



Battery fully charged  
(if not animated)

You can disconnect and use iPod mini before it is fully charged.

# Tips and Troubleshooting

Most problems with iPod mini can be solved quickly by following the advice in this chapter.

## Resetting iPod mini

Most problems with iPod mini can be solved by resetting iPod mini.

### To reset iPod mini:

- 1 Connect iPod mini to a power outlet using the iPod Power Adapter.
- 2 Toggle the Hold switch on and off (set it to hold, then turn it off again).
- 3 Press and hold the Menu and Select buttons for at least 6 seconds, until the Apple logo appears.

## If Your iPod mini Won't Turn On or Respond

- Make sure the Hold switch is off.
- If you're using the iPod Remote, make sure the remote's Hold switch is off.
- If that doesn't work, connect iPod mini to the power adapter and connect the adapter to a working electrical outlet. Your battery may need to be recharged.
- If that doesn't work, your iPod mini may need to be reset (see above).

- If you are using the optional iPod Dock Connector to USB 2.0 + FireWire Cable and your computer has USB and FireWire ports, don't plug the cable's USB and FireWire connectors in to your computer at the same time. If you have done this, unplug the cables and reset iPod mini (see above).
- If that doesn't work, you may need to restore iPod mini software. To download the latest version of iPod mini software, go to [www.apple.com/ipod](http://www.apple.com/ipod).

### If You Want to Disconnect iPod mini, but the Screen Says "Do Not Disconnect"

- If iPod mini is transferring music, wait for the transfer to complete.
- Select iPod mini in the iTunes Source list and click the Eject button.
- If iPod mini disappears from the iTunes Source list, but you still see the "Do Not Disconnect" message on the screen, go ahead and disconnect iPod mini.
- If iPod mini doesn't disappear from the iTunes Source list, drag the iPod mini icon from the desktop to the Trash (if you're using a Mac) or click the Safely Remove Hardware icon in the system tray and select your iPod mini (if you're using a Windows PC). If you still see the "Do Not Disconnect" message, restart your computer and eject iPod mini again.

### If Your iPod mini Isn't Playing Music

- Make sure the Hold switch is off.
- If you're using the iPod Remote, make sure the remote's Hold switch is off.
- Make sure the headphones connector is pushed in all the way.
- Make sure the volume is adjusted properly.
- If that doesn't work, push the Play/Pause button on the Click Wheel. Your iPod mini may be paused.
- If you are using the optional iPod mini Dock, be sure the iPod mini is seated firmly in the Dock and make sure all cables are connected properly.
- If you are using the Dock Line Out port, make sure your external speakers or stereo are turned on and working properly.

### If You Connect iPod mini to Your Computer and Nothing Happens

- Make sure you have the required computer and software. See "What You Need to Get Started" on page 5.
- Your iPod mini may need to be reset (see page 46).
- Check the cable connections. Unplug the cable at both ends and make sure no foreign objects are in the FireWire or USB 2.0 ports. Then plug the cable back in securely. Use only Apple iPod cables and adapters. Be sure the connectors on the cable are oriented correctly. They can only be inserted one way.
- If you're connecting iPod mini to a Windows PC using the USB 2.0 cable, be sure you're connecting it to a high-power USB 2.0 port. Typically, USB 2.0 ports located directly on your computer are high-power ports.

- If you're connecting iPod mini to a Windows PC laptop computer using the USB 2.0 cable, connect the laptop to a power outlet before connecting iPod.
- If that doesn't work, restart your computer.
- If that doesn't work, you may need to restore iPod mini software. To download the latest version of iPod mini software, go to [www.apple.com/ipod](http://www.apple.com/ipod).
- For more information, go to the iPod support site at [www.apple.com/support/ipod](http://www.apple.com/support/ipod).

### If You Connect iPod mini to a USB Port and It Doesn't Work Correctly

- If you're using a Mac, connect iPod mini to a FireWire port on your Mac using the FireWire cable.
- If you're using iPod mini with a USB 1.1 port on your computer, you must use a FireWire port or a high-power USB 2.0 port. USB 1.1 is not supported and is significantly slower than FireWire and USB 2.0. If your Windows PC doesn't have a FireWire port or high-power USB 2.0 port, you can purchase a Windows-certified FireWire card or USB 2.0 card and install it. For more information, go to [www.apple.com/ipod](http://www.apple.com/ipod).
- If you're connecting iPod mini to a Windows PC using the USB cable, be sure you're connecting it to a high-power USB 2.0 port. Typically, USB 2.0 high-power ports are located directly on your computer.

**Note:** You can also connect iPod mini to a self-powered USB 2.0 hub that's connected to a high-power USB 2.0 port on your computer.

- If you're connecting iPod mini to a Windows PC laptop computer using the USB cable, connect the laptop to a power outlet before connecting iPod.

- If you're connecting iPod mini to a Windows PC using a USB cable, and it has been a long time since you've used your iPod mini or charged it, the battery may be very low. It may take up to 10 minutes before the iPod mini battery is charged enough to begin transferring music. Leave iPod mini connected to your computer while it charges. After a few minutes, the low-battery icon disappears and your iPod mini connects normally.

### If Your Optional iPod Remote Isn't Working

- Make sure the remote's Hold switch is off.
- Make sure the remote is plugged firmly in to iPod mini, and that the headphones are plugged firmly in to the remote.

The iPod Remote is available for purchase at [www.apple.com/store](http://www.apple.com/store).

### Software Update

Apple periodically updates iPod software to improve performance or add features. It is recommended that you update your iPod mini to use the latest software. To download the latest version of iPod mini software, go to [www.apple.com/ipod](http://www.apple.com/ipod).

If you use the iPod mini software updater application and it doesn't see that iPod mini is connected to your computer, reset iPod mini (see page 46).

# Learning More, Service, and Support

There is more information about using iPod mini on your hard disk, on the web, and in onscreen help.

## iPod mini Tutorial

For an in-depth tutorial on transferring music to and playing music on iPod mini, see the *iPod mini Tutorial* on the iPod mini CD.

## Online Resources

For the latest information on iPod mini, go to [www.apple.com/ipod](http://www.apple.com/ipod).

To register iPod mini (if you didn't do it when you installed software from the iPod mini CD) go to [www.apple.com/register](http://www.apple.com/register).

For iPod service and support information, a variety of forums with product-specific information and feedback, and the latest Apple software downloads, go to [www.apple.com/support/ipod](http://www.apple.com/support/ipod).

For support outside of the United States, go to [www.apple.com/support](http://www.apple.com/support) and choose your country from the pop-up menu.

For an online iTunes tutorial (available in some areas only), go to [www.info.apple.com/usen/itunes](http://www.info.apple.com/usen/itunes).

## Onscreen Help

- To learn more about using iTunes, open iTunes and choose Help > iTunes and Music Store Help.
- To learn more about using iSync (on Mac OS X), open iSync and choose Help > iSync Help.
- To learn more about using iCal (on Mac OS X), open iCal and choose Help > iCal Help.

## iPod mini User's Guide

This booklet is also included as a file on the iPod mini CD.

## Obtaining Warranty Service

If the product appears to be damaged or does not function properly, please follow the advice in this booklet, the onscreen help, and the online resources.

If the unit still does not function, go to [www.apple.com/support](http://www.apple.com/support) for instructions on how to obtain warranty service.

## Finding the Serial Number of Your iPod mini

The serial number is printed on the back of your iPod mini. You can also find it by selecting Settings > About.

# Safety and Cleaning

Read on to learn about using iPod mini safely and cleaning iPod mini.

## Important Safety Instructions

When setting up and using your iPod mini, remember the following:

- Read all the installation instructions carefully before you plug your iPod Power Adapter in to a power outlet.
- Keep these instructions handy for reference by you and others.
- Follow all instructions and warnings dealing with your iPod mini.

**Warning** Electrical equipment may be hazardous if misused. Operation of this product, or similar products, must always be supervised by an adult. Do not allow children access to the interior of any electrical product and do not permit them to handle any cables.

## Avoid Hearing Damage

**Warning** Permanent hearing loss may occur if earbuds or headphones are used at high volume. You can adapt over time to a higher volume of sound, which may sound normal but can be damaging to your hearing. Set your iPod mini volume to a safe level before that happens. If you experience ringing in your ears, reduce the volume or discontinue use of your iPod mini.

## Do Not Use While Driving

**Important:** Use of headphones while operating a vehicle is not recommended and is illegal in some areas. Be careful and attentive while driving. Stop listening to your iPod mini if you find it disruptive or distracting while operating any type of vehicle or performing any other activity that requires your full attention.

## Connectors and Ports

Never force a connector into a port. If the connector and port do not join with reasonable ease, they probably don't match. Make sure that the connector matches the port and that you have positioned the connector correctly in relation to the port.

## Battery

Do not attempt to remove the iPod mini battery. iPod mini must be disposed of according to local environmental battery disposal regulations.

## Using the Power Adapter

- Use only the power adapter that came with your iPod mini. Adapters for other electronic devices may look similar, but they may damage your iPod mini.
- The only way to shut off power completely to your power adapter is to disconnect it from the power source.
- Always leave space around your power adapter. Do not use this equipment in a location where airflow around the power adapter is confined, such as a bookcase.
- When connecting or disconnecting your power adapter, always hold the power adapter by its sides. Keep fingers away from the metal part of the plug.
- Before connecting the FireWire cable to the power adapter, make sure there are no foreign objects inside the power adapter's FireWire port.
- The power adapter for your iPod mini is a high-voltage component and should not be opened for any reason, even when the iPod mini is off. If the power adapter needs service, see "Learning More, Service, and Support" on page 51.
- Never force a connector into the power adapter FireWire port. If the connector and port do not join with reasonable ease, they probably don't match. Make sure that the connector matches the port and that you have positioned the connector correctly in relation to the port.

## About Operating and Storage Temperatures

- Operate your iPod mini in a place where the temperature is always between 0° and 35° C (32° to 95° F).
- Store your iPod mini in a place where the temperature is always between –20° and 45° C (–4° to 113° F).
- iPod mini battery life may shorten in low-temperature conditions.
- When you are using your iPod mini or charging the battery, it is normal for the bottom of the case to get warm. The bottom of the iPod mini case functions as a cooling surface that transfers heat from inside the unit to the cooler air outside.

## Avoid Wet Locations

**Warning** To reduce the chance of shock or injury, do not use your iPod mini in or near water or wet locations.

- Keep your iPod mini and power adapter away from sources of liquids, such as drinks, washbasins, bathtubs, shower stalls, and so on.
- Protect your iPod mini and the power adapter from direct sunlight and rain or other moisture.
- Take care not to spill any food or liquid on iPod mini or its power adapter. If you do, unplug iPod mini before cleaning up the spill.

In case of a spill, you may have to send your equipment to Apple for service. See “Learning More, Service, and Support” on page 51.

## Do Not Make Repairs Yourself

**Warning** Do not attempt to open your iPod mini or power adapter, disassemble it, or remove the battery. You run the risk of electric shock and voiding the limited warranty. No user-serviceable parts are inside.

For service, see “Learning More, Service, and Support” on page 51.

## Cleaning

Follow these general rules when cleaning the outside of your iPod mini and its components:

- Make sure your iPod mini is unplugged.
- Use a damp, soft, lint-free cloth. Avoid getting moisture in openings.
- Don't use aerosol sprays, solvents, alcohol, or abrasives.

## About Handling

Your iPod mini may be damaged by improper storage or handling. Be careful not to drop your iPod mini when playing or transporting the device.

## Communications Regulation Information

### FCC Compliance Statement

This device complies with part 15 of the FCC rules. Operation is subject to the following two conditions: (1) This device may not cause harmful interference, and (2) this device must accept any interference received, including interference that may cause undesired operation. See instructions if interference to radio or television reception is suspected.

### Radio and Television Interference

This computer equipment generates, uses, and can radiate radio-frequency energy. If it is not installed and used properly—that is, in strict accordance with Apple’s instructions—it may cause interference with radio and television reception.

This equipment has been tested and found to comply with the limits for a Class B digital device in accordance with the specifications in Part 15 of FCC rules. These specifications are designed to provide reasonable protection against such interference in a residential installation. However, there is no guarantee that interference will not occur in a particular installation.

You can determine whether your computer system is causing interference by turning it off. If the interference stops, it was probably caused by the computer or one of the peripheral devices.

If your computer system does cause interference to radio or television reception, try to correct the interference by using one or more of the following measures:

- Turn the television or radio antenna until the interference stops.
- Move the computer to one side or the other of the television or radio.
- Move the computer farther away from the television or radio.
- Plug the computer into an outlet that is on a different circuit from the television or radio. (That is, make certain the computer and the television or radio are on circuits controlled by different circuit breakers or fuses.)

If necessary, consult an Apple Authorized Service Provider or Apple. See the service and support information that came with your Apple product. Or, consult an experienced radio/television technician for additional suggestions.

**Important:** Changes or modifications to this product not authorized by Apple Computer, Inc. could void the EMC compliance and negate your authority to operate the product.

This product was tested for EMC compliance under conditions that included the use of Apple peripheral devices and Apple shielded cables and connectors between system components. It is important that you use Apple peripheral devices and shielded cables and connectors between system components to reduce the possibility of causing interference to radios, television sets, and other electronic devices. You can obtain Apple peripheral devices and the proper shielded cables and connectors through an Apple Authorized Reseller. For non-Apple peripheral devices, contact the manufacturer or dealer for assistance. Responsible party (contact for FCC matters only): Apple Computer, Inc. Product Compliance, 1 Infinite Loop M/S 26-A, Cupertino, CA 95014-2084, 408-974-2000.

#### **Industry Canada Statement**

This Class B device meets all requirements of the Canadian interference-causing equipment regulations.

Cet appareil numérique de la classe B respecte toutes les exigences du Règlement sur le matériel brouilleur du Canada.

#### **Apple and the Environment**

At Apple, we recognize our responsibility to minimize the environmental impacts of our operations and products. For more information go to [www.apple.com/about/environment](http://www.apple.com/about/environment).

© 2004 Apple Computer, Inc. All rights reserved.

Apple, the Apple logo, Apple Store, FireWire, iTunes, Mac, Macintosh, and Mac OS are trademarks of Apple Computer, Inc., registered in the U.S. and other countries.

Finder, the FireWire logo, iCal, and iPod are trademarks of Apple Computer, Inc.

[www.apple.com/ipod](http://www.apple.com/ipod)  
[www.apple.com/support/ipod](http://www.apple.com/support/ipod)

034-2532-A  
Printed in XXXX



**iPod mini**  
Quick Reference

## Using iPod mini Controls

Use the iPod mini Click Wheel and Select button (in the center) to navigate through onscreen menus, play songs, change settings, and view information. Move your thumb lightly around the Click Wheel to scroll to a menu item. Press the Select button to select the item. Press Menu on the Click Wheel to go back to the previous menu.

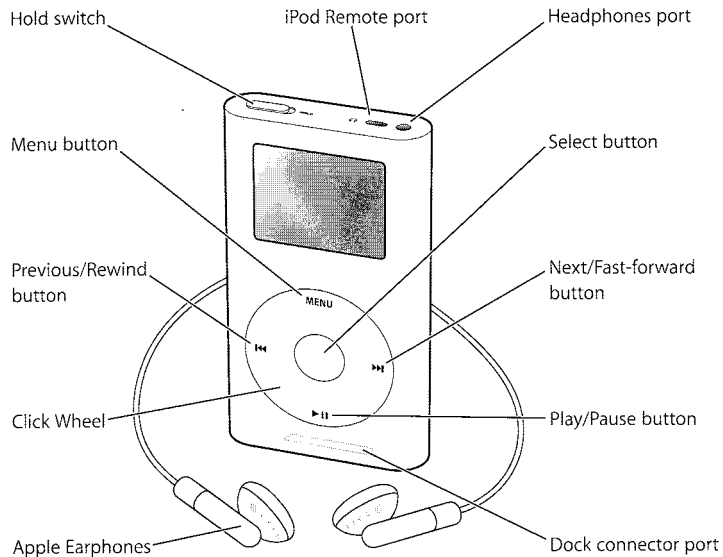

## iPod mini Controls

<b>Reset iPod mini</b> (For use during troubleshooting)	Toggle the Hold switch (set it to hold, then turn it off again). Then press the Menu and Select buttons simultaneously for about 6 seconds, until the Apple logo appears.
<b>Turn iPod mini on</b>	Press the Select button.
<b>Turn iPod mini off</b>	Press and hold Play/Pause.
<b>Turn the backlight on or off</b>	Press and hold Menu or select Backlight from the main menu.
<b>Select a menu item</b>	Scroll to the item and press the Select button.
<b>Go back to the previous menu</b>	Press Menu.
<b>Browse for a song</b>	Select Playlists or Browse from the main menu.
<b>Play a song</b>	Highlight the song and press the Select or Play/Pause button.
<b>Play all the songs in a list</b>	Highlight the list title (an album title, or the title of a playlist, for example) and press Play/Pause.
<b>Change the volume</b>	From the Now Playing screen, use the Click Wheel. You can also use the optional iPod Remote (available at <a href="http://www.apple.com/store">www.apple.com/store</a> ) from any screen.
<b>Pause a song</b>	Press Play/Pause when no song or list is highlighted.
<b>Disable iPod mini controls</b> (So you don't activate them accidentally)	Set the Hold switch to hold (an orange bar appears).

## iPod mini Controls

Skip to any point in a song	From the Now Playing screen, press the Select button. Then scroll to any point in the song.
Skip to the next song	Press Next/Fast-forward.
Start a song over	Press Previous/Rewind.
Play the previous song	Press Previous/Rewind twice.
Fast-forward	Press and hold Next/Fast-forward.
Rewind	Press and hold Previous/Rewind.

## Tutorial

For an in-depth tutorial on transferring music to and playing music on iPod mini, see the *iPod mini Tutorial* on the iPod mini CD.

© 2004 Apple Computer, Inc. All rights reserved.

Apple and the Apple logo are trademarks of Apple Computer, Inc., registered in the U.S. and other countries. iPod is a trademark of Apple Computer, Inc.

Printed in Taiwan

034-2428-A



## Apple One-Year Limited Warranty

Apple's warranty obligations for this hardware product are limited to the terms set forth below:

Apple Computer, Inc. ("Apple") warrants this hardware product against defects in materials and workmanship for a period of one (1) year from the date of original purchase ("Warranty Period").

If a defect arises and a valid claim is received by Apple within the Warranty Period, at its option, Apple will (1) repair the product at no charge, using new or refurbished replacement parts, (2) exchange the product with a product that is new or which has been manufactured from new or serviceable used parts and is at least functionally equivalent to the original product, or (3) refund the purchase price of the product.

If a defect arises and a valid claim is received by Apple after the first one hundred and eighty (180) days of the Warranty Period, a shipping and handling charge will apply to any repair or exchange of the product undertaken by Apple.

Apple warrants replacement products or parts provided under this warranty against defects in materials and workmanship from the date of the replacement or repair for ninety (90) days or for the remaining portion of the original product's warranty, whichever provides longer coverage for you. When a product or part is exchanged, any replacement item becomes your property and the replaced item becomes Apple's property. When a refund is given, your product becomes Apple's property.

### EXCLUSIONS AND LIMITATIONS

This Limited Warranty applies only to the hardware product manufactured by or for Apple that can be identified by the "Apple" trademark, trade name, or logo affixed to it. This Limited Warranty does not apply to any non-Apple hardware product or any software, even if packaged or sold with the Apple hardware product. Non-Apple manufacturers, suppliers, or publishers may provide a separate warranty for their own products packaged with the Apple hardware product.

Software distributed by Apple under the Apple brand name is not covered under this Limited Warranty. Refer to Apple's Software License Agreement for more information.

Apple is not liable for any damage to or loss of any programs, data, or other information stored on any media contained within the Apple hardware product, or any non-Apple product or part not covered by this warranty. Recovery or reinstallation of programs, data or other information is not covered under this Limited Warranty.

This warranty does not apply: (a) to damage caused by accident, abuse, misuse, misapplication, or non-Apple products; (b) to damage caused by service performed by anyone other than Apple; (c) to a product or a part that has been modified without the written permission of Apple; or (d) if any Apple serial number has been removed or defaced.

TO THE MAXIMUM EXTENT PERMITTED BY LAW, THIS WARRANTY AND THE REMEDIES SET FORTH ABOVE ARE EXCLUSIVE AND IN LIEU OF ALL OTHER WARRANTIES, REMEDIES AND CONDITIONS, WHETHER ORAL OR WRITTEN, EXPRESS OR IMPLIED. APPLE SPECIFICALLY DISCLAIMS ANY AND ALL IMPLIED WARRANTIES, INCLUDING, WITHOUT LIMITATION, WARRANTIES OF MERCHANTABILITY AND FITNESS FOR A PARTICULAR PURPOSE. IF APPLE CANNOT LAWFULLY DISCLAIM OR EXCLUDE IMPLIED WARRANTIES UNDER APPLICABLE LAW, THEN TO THE EXTENT POSSIBLE ANY CLAIMS UNDER SUCH IMPLIED WARRANTIES SHALL EXPIRE ON EXPIRATION OF THE WARRANTY PERIOD. No Apple reseller, agent, or employee is authorized to make any modification, extension, or addition to this warranty.

TO THE MAXIMUM EXTENT PERMITTED BY LAW, APPLE IS NOT RESPONSIBLE FOR DIRECT, SPECIAL, INCIDENTAL OR CONSEQUENTIAL DAMAGES RESULTING FROM ANY BREACH OF WARRANTY OR CONDITION, OR UNDER ANY OTHER LEGAL THEORY, INCLUDING ANY COSTS OF RECOVERING OR REPRODUCING ANY PROGRAM OR DATA STORED IN OR USED WITH THE APPLE PRODUCT, AND ANY FAILURE TO MAINTAIN THE CONFIDENTIALITY OF DATA STORED ON THE PRODUCT. APPLE SPECIFICALLY DOES NOT REPRESENT THAT IT WILL BE ABLE TO REPAIR ANY PRODUCT UNDER THIS WARRANTY OR MAKE A PRODUCT EXCHANGE WITHOUT RISK TO OR LOSS OF PROGRAMS OR DATA.

FOR CONSUMERS WHO HAVE THE BENEFIT OF CONSUMER PROTECTION LAWS OR REGULATIONS IN THEIR COUNTRY OF PURCHASE OR, IF DIFFERENT, THEIR COUNTRY OF RESIDENCE, THE BENEFITS CONFERRED BY THIS WARRANTY ARE IN ADDITION TO ALL RIGHTS AND REMEDIES CONVEYED BY SUCH CONSUMER PROTECTION LAWS AND REGULATIONS. TO THE EXTENT THAT LIABILITY UNDER SUCH CONSUMER PROTECTION LAWS AND REGULATIONS MAY BE LIMITED, APPLE'S LIABILITY IS LIMITED, AT ITS SOLE OPTION TO REPLACEMENT OR REPAIR OF THE PRODUCT OR SUPPLY OF THE REPAIR SERVICE AGAIN.

#### **OBTAINING WARRANTY SERVICE**

Please review the online help resources referred to in the accompanying documentation before seeking warranty service. If the product is still not functioning properly after making use of these resources, access the online website: [www.apple.com/support](http://www.apple.com/support) for instructions on how to obtain warranty service.

**Note: Before you deliver your product for warranty service it is your responsibility to backup all data, including all software programs. You will be responsible for reinstalling all data. Data recovery is not included in the warranty service and Apple is not responsible for data that may be lost or damaged during transit or a repair.**



# Apple Computer, Inc. Software License Agreement Single Use License

**PLEASE READ THIS SOFTWARE LICENSE AGREEMENT (“LICENSE”) CAREFULLY BEFORE USING THE SOFTWARE. BY USING THE SOFTWARE, YOU ARE AGREEING TO BE BOUND BY THE TERMS OF THIS LICENSE. IF YOU DO NOT AGREE TO THE TERMS OF THIS LICENSE, DO NOT USE THE APPLE SOFTWARE AND (IF APPLICABLE) RETURN THE APPLE SOFTWARE TO THE PLACE WHERE YOU OBTAINED IT FOR A REFUND.**

**IMPORTANT NOTE:** This software may be used to reproduce materials. It is licensed to you only for reproduction of non-copyrighted materials, materials in which you own the copyright, or materials you are authorized or legally permitted to reproduce. If you are uncertain about your right to copy any material you should contact your legal advisor.

**1. General.** The software (including Boot ROM code), documentation and any fonts accompanying this License whether on disk, in read only memory, on any other media or in any other form (collectively the “Apple Software”) are licensed, not sold, to you by Apple Computer, Inc. (“Apple”) for use only under the terms of this License, and Apple reserves all rights not expressly granted to you. The rights granted herein are limited to Apple’s intellectual property rights in the Apple Software and do not include any other patents or intellectual property rights. You own the media on which the Apple Software is recorded but Apple and/or Apple’s licensor(s) retain ownership of the Apple Software itself.

**2. Permitted License Uses and Restrictions.** This License allows you to install and use one copy of the Apple Software on a single Apple-labeled device or computer at a time. The Apple Software may be used to reproduce materials so long as such use is limited to reproduction of non-copyrighted materials, materials in which you own the copyright, or materials you are authorized or legally permitted to reproduce. This License does not allow the Apple Software to exist on more than one such device or computer at a time, and you may not make the Apple Software available over a network where it could be used by multiple devices or multiple computers at the same time. You may make one copy of the Apple Software (excluding the Boot ROM code) in machine-readable form for backup purposes only; provided that the backup copy must include all copyright or other proprietary notices contained on the original. Except as and only to the extent expressly permitted in this License or by applicable law, you may not copy, decompile, reverse engineer, disassemble, attempt to derive the source code of, modify, or create derivative works of the Apple Software or any part thereof. Any attempt to do so is a violation of the rights of Apple and its licensors of the Apple Software. If you breach this restriction, you may be subject to prosecution and damages. THE APPLE SOFTWARE IS NOT INTENDED FOR USE IN THE OPERATION OF NUCLEAR FACILITIES,

AIRCRAFT NAVIGATION OR COMMUNICATION SYSTEMS, AIR TRAFFIC CONTROL SYSTEMS, LIFE SUPPORT MACHINES OR OTHER EQUIPMENT IN WHICH THE FAILURE OF THE APPLE SOFTWARE COULD LEAD TO DEATH, PERSONAL INJURY, OR SEVERE PHYSICAL OR ENVIRONMENTAL DAMAGE.

**3. Transfer.** You may not rent, lease, lend or sublicense the Apple Software. You may, however, make a one-time permanent transfer of all of your license rights to the Apple Software to another party, provided that: (a) the transfer must include all of the Apple Software, including all its component parts, original media, printed materials and this License; (b) you do not retain any copies of the Apple Software, full or partial, including copies stored on a computer or other storage device; and (c) the party receiving the Apple Software reads and agrees to accept the terms and conditions of this License.

**4. Termination.** This License is effective until terminated. Your rights under this License will terminate automatically without notice from Apple if you fail to comply with any term(s) of this License. Upon the termination of this License, you shall cease all use of the Apple Software and destroy all copies, full or partial, of the Apple Software.

**5. Limited Warranty on Media (if applicable).** Apple warrants the media on which the Apple Software is recorded and delivered by Apple (if any) to be free from defects in materials and workmanship under normal use for a period of ninety (90) days from the date of original retail purchase. Your exclusive remedy under this Section shall be, at Apple's option, a refund of the purchase price of the product containing the Apple Software or replacement of the Apple Software which is returned to Apple or an Apple authorized representative with a copy of the receipt. THIS LIMITED WARRANTY AND ANY IMPLIED WARRANTIES ON THE MEDIA INCLUDING, BUT NOT LIMITED TO, THE IMPLIED WARRANTIES OF MERCHANTABILITY, OF SATISFACTORY QUALITY, AND OF FITNESS FOR A PARTICULAR PURPOSE, ARE LIMITED IN DURATION TO NINETY (90) DAYS FROM THE DATE OF ORIGINAL RETAIL PURCHASE. SOME JURISDICTIONS DO NOT ALLOW LIMITATIONS ON HOW LONG AN IMPLIED WARRANTY LASTS, SO THE ABOVE LIMITATION MAY NOT APPLY TO YOU. THE LIMITED WARRANTY SET FORTH HEREIN IS THE ONLY WARRANTY MADE TO YOU AND IS PROVIDED IN LIEU OF ANY OTHER WARRANTIES (IF ANY) CREATED BY ANY DOCUMENTATION OR PACKAGING. THIS LIMITED WARRANTY GIVES YOU SPECIFIC LEGAL RIGHTS, AND YOU MAY ALSO HAVE OTHER RIGHTS WHICH VARY BY JURISDICTION.

**6. Disclaimer of Warranties.** YOU EXPRESSLY ACKNOWLEDGE AND AGREE THAT USE OF THE APPLE SOFTWARE IS AT YOUR SOLE RISK AND THAT THE ENTIRE RISK AS TO SATISFACTORY QUALITY, PERFORMANCE, ACCURACY AND EFFORT IS WITH YOU. EXCEPT FOR THE LIMITED WARRANTY ON MEDIA SET FORTH ABOVE AND TO THE MAXIMUM EXTENT PERMITTED BY APPLICABLE LAW, THE APPLE SOFTWARE IS PROVIDED "AS IS", WITH ALL FAULTS AND WITHOUT WARRANTY OF ANY KIND, AND APPLE AND APPLE'S LICENSORS (COLLECTIVELY REFERRED TO AS "APPLE" FOR THE PURPOSES OF SECTIONS 6 AND 7) HEREBY DISCLAIM ALL WARRANTIES AND CONDITIONS WITH RESPECT TO THE APPLE SOFTWARE, EITHER EXPRESS, IMPLIED OR STATUTORY, INCLUDING, BUT NOT LIMITED TO, THE IMPLIED WARRANTIES AND/OR CONDITIONS OF MERCHANTABILITY, OF SATISFACTORY QUALITY, OF FITNESS FOR A PARTICULAR PURPOSE, OF ACCURACY, OF QUIET ENJOYMENT, AND NON-INFRINGEMENT OF THIRD PARTY RIGHTS. APPLE DOES NOT WARRANT AGAINST INTERFERENCE WITH YOUR ENJOYMENT OF THE APPLE SOFTWARE, THAT THE FUNCTIONS CONTAINED IN THE APPLE SOFTWARE WILL MEET YOUR REQUIREMENTS, THAT THE OPERATION OF THE APPLE SOFTWARE WILL BE UNINTERRUPTED OR ERROR-FREE, OR THAT DEFECTS IN THE APPLE SOFTWARE WILL BE CORRECTED. NO ORAL OR WRITTEN INFORMATION OR ADVICE GIVEN BY APPLE OR AN APPLE AUTHORIZED

REPRESENTATIVE SHALL CREATE A WARRANTY. SHOULD THE APPLE SOFTWARE PROVE DEFECTIVE, YOU ASSUME THE ENTIRE COST OF ALL NECESSARY SERVICING, REPAIR OR CORRECTION. SOME JURISDICTIONS DO NOT ALLOW THE EXCLUSION OF IMPLIED WARRANTIES OR LIMITATIONS ON APPLICABLE STATUTORY RIGHTS OF A CONSUMER, SO THE ABOVE EXCLUSION AND LIMITATIONS MAY NOT APPLY TO YOU.

**7. Limitation of Liability.** TO THE EXTENT NOT PROHIBITED BY LAW, IN NO EVENT SHALL APPLE BE LIABLE FOR PERSONAL INJURY, OR ANY INCIDENTAL, SPECIAL, INDIRECT OR CONSEQUENTIAL DAMAGES WHATSOEVER, INCLUDING, WITHOUT LIMITATION, DAMAGES FOR LOSS OF PROFITS, LOSS OF DATA, BUSINESS INTERRUPTION OR ANY OTHER COMMERCIAL DAMAGES OR LOSSES, ARISING OUT OF OR RELATED TO YOUR USE OR INABILITY TO USE THE APPLE SOFTWARE, HOWEVER CAUSED, REGARDLESS OF THE THEORY OF LIABILITY (CONTRACT, TORT OR OTHERWISE) AND EVEN IF APPLE HAS BEEN ADVISED OF THE POSSIBILITY OF SUCH DAMAGES. SOME JURISDICTIONS DO NOT ALLOW THE LIMITATION OF LIABILITY FOR PERSONAL INJURY, OR OF INCIDENTAL OR CONSEQUENTIAL DAMAGES, SO THIS LIMITATION MAY NOT APPLY TO YOU. In no event shall Apple's total liability to you for all damages (other than as may be required by applicable law in cases involving personal injury) exceed the amount of fifty dollars (\$50.00). The foregoing limitations will apply even if the above stated remedy fails of its essential purpose.

**8. Export Law Assurances.** You may not use or otherwise export or reexport the Apple Software except as authorized by United States law and the laws of the jurisdiction in which the Apple Software was obtained. In particular, but without limitation, the Apple Software may not be exported or re-exported (a) into (or to a national or resident of) any U.S. embargoed countries (currently Cuba, Iran, Iraq, Libya, North Korea, Sudan and Syria) or (b) to anyone on the U.S. Treasury Department's list of Specially Designated Nationals or the U.S. Department of Commerce Denied Person's List or Entity List. By using the Apple Software, you represent and warrant that you are not located in, under control of, or a national or resident of any such country or on any such list

**9. Government End Users.** The Apple Software and related documentation are "Commercial Items", as that term is defined at 48 C.F.R. §2.101, consisting of "Commercial Computer Software" and "Commercial Computer Software Documentation", as such terms are used in 48 C.F.R. §12.212 or 48 C.F.R. §227.7202, as applicable. Consistent with 48 C.F.R. §12.212 or 48 C.F.R. §227.7202-1 through 227.7202-4, as applicable, the Commercial Computer Software and Commercial Computer Software Documentation are being licensed to U.S. Government end users (a) only as Commercial Items and (b) with only those rights as are granted to all other end users pursuant to the terms and conditions herein. Unpublished-rights reserved under the copyright laws of the United States.

**10. Controlling Law and Severability.** This License will be governed by and construed in accordance with the laws of the State of California, as applied to agreements entered into and to be performed entirely within California between California residents. This License shall not be governed by the United Nations Convention on Contracts for the International Sale of Goods, the application of which is expressly excluded. If for any reason a court of competent jurisdiction finds any provision, or portion thereof, to be unenforceable, the remainder of this License shall continue in full force and effect.

**11. Third Party Beneficiary.** You are hereby notified that PortalPlayer, Inc., a California corporation located at 3255 Scott Boulevard, Building 1, Santa Clara, California 95054, U.S.A. is a third party beneficiary to this License to the extent that this License contains provisions which relate to your use, reproduction, or other distribution of the

PortalPlayer software. Such provisions are made expressly for the benefit of PortalPlayer and are enforceable by PortalPlayer in addition to Apple.

**12. Third Party Notices and Conditions.** The Apple Software may include or utilize certain software which is owned by Netscape Communications Corporation, the source code of which is available under the Netscape Public License, version 1.1 (the "NPL'ed Code"). Apple may make modifications to this NPL'ed Code, in which case the source code of such Apple modifications, as well as a copy of the Netscape Public License, will be included with the Apple Software.

**13. Complete Agreement; Governing Language.** This License constitutes the entire agreement between the parties with respect to the use of the Apple Software licensed hereunder and supersedes all prior or contemporaneous understandings regarding such subject matter. No amendment to or modification of this License will be binding unless in writing and signed by Apple. Any translation of this License is done for local requirements and in the event of a dispute between the English and any non-English versions, the English version of this License shall govern.

**14. Use of MPEG-4.** This product is licensed under the MPEG-4 Systems Patent Portfolio License for encoding in compliance with the MPEG-4 Systems Standard, except that an additional license and payment of royalties are necessary for encoding in connection with (i) data stored or replicated in physical media which is paid for on a title by title basis and/or (ii) data which is paid for on a title by title basis and is transmitted to an end user for permanent storage and/or use. Such additional license may be obtained from MPEG LA, LLC. See <http://www.mpegla.com> for additional details.

Additional use licenses and fees are required for use of information encoded in compliance with the MPEG-4 Visual Standard other than the personal and non-commercial use of a consumer (i) in connection with information which has been encoded in compliance with the MPEG-4 Visual Standard by a consumer engaged in a personal and non-commercial activity and/or (ii) in connection with MPEG-4 encoded video under license from a video provider. Additional information including that relating to promotional, internal and commercial uses and licensing may be obtained from MPEG LA, LLC. See <http://www.mpegla.com>.

### **Making Digital Copies**

By storing content on this product you are making a digital copy. This product is for legal or rightholder authorized use only. In some jurisdictions, it is unlawful to make digital copies without prior permission from the rightholder.

© 2003 Apple Computer, Inc. All rights reserved. Apple, Apple logo and iPod are trademarks of Apple Computer, Inc., registered in the U.S.A. and other countries.  
Portions © PortalPlayer, Inc. 2003. All rights reserved. PORTALPLAYER, TANGO, SUPERINTEGRATION and the PortalPlayer logo are trademarks owned by PortalPlayer, Inc.  
MPEG Layer-3 audio compression technology licensed by Fraunhofer IIS and THOMSON multimedia. <http://www.iis.fhg.de/amm/>

Printed in Taiwan  
EA0179A  
033-2229-A

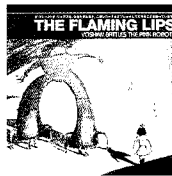
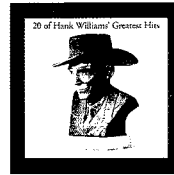
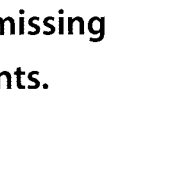
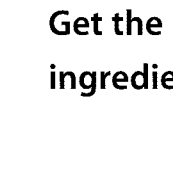
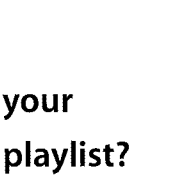
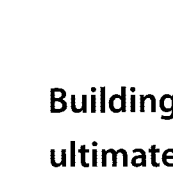
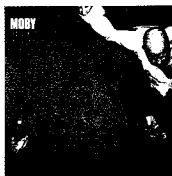
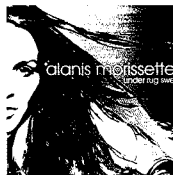

Building your  
ultimate playlist?  
Get the missing  
ingredients.

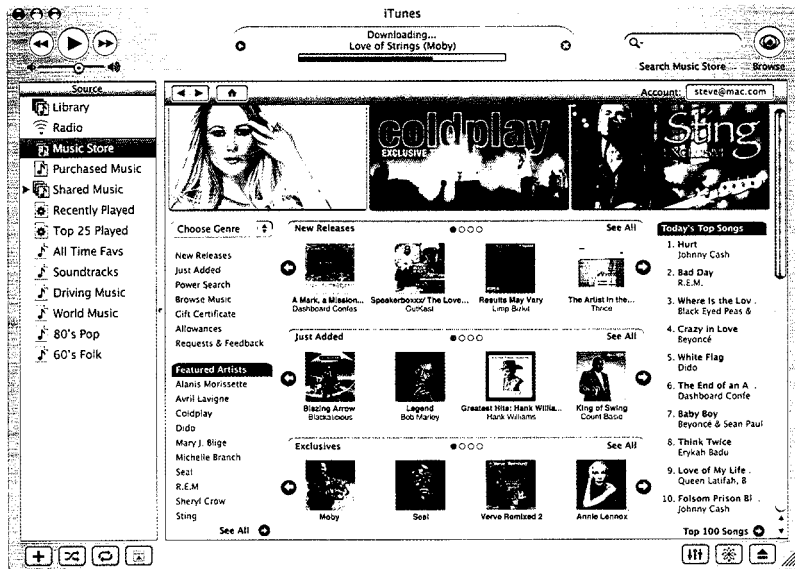

## Visit the iTunes Music Store to complete your collection.

Everything you want to hear is here. Just install iTunes from the CD, then choose from countless songs in all music genres. Preview any track and download it for just 99¢. Happy listening.

For legal or rightholder-authorized copying only. Don't steal music. The iTunes Music Store is available only in the U.S. Requires iTunes 4; Mac OS X v10.1.5 or later (Mac OS X v10.2.8 or later recommended), Windows 2000, or Windows XP; and Internet access (fees may apply). Music Store image shown for illustration purposes only. Terms apply. TM and © 2003 Apple Computer, Inc. All rights reserved. Printed in Taiwan.



## **iPod mini**

### **Tutorial**

Includes lessons on transferring music to iPod mini, playing music, and storing files on iPod mini

 Apple Computer, Inc.

© 2004 Apple Computer, Inc. All rights reserved.

Apple, the Apple logo, Apple Store, FireWire, iTunes, Mac, Macintosh, and Mac OS are trademarks of Apple Computer, Inc., registered in the U.S. and other countries.

The FireWire logo and iPod are trademarks of Apple Computer, Inc.

022-1519

# Contents

<b>Preface</b>	<b>5 iPod mini and iTunes at a Glance</b>
	5 How to Use the Tutorial
	6 Before You Begin
<b>Chapter 1</b>	<b>11 Lesson 1: Getting Music Into iTunes</b>
	12 Before You Begin
	12 Importing Music From Your Audio CDs Into iTunes
	13 Buying Songs Online Using the iTunes Music Store
	14 Adding Songs Already on Your Computer to the iTunes Library
	14 Once You Have Imported Songs
<b>Chapter 2</b>	<b>15 Lesson 2: Transferring Music to iPod mini</b>
	15 Before You Begin
	16 Charging the iPod mini Battery
	16 Connecting iPod mini to Your Computer
	18 Transferring Music to iPod mini
	19 Disconnecting iPod mini After Transferring Music
	19 Once You Have Transferred Music
<b>Chapter 3</b>	<b>20 Lesson 3: Playing Music on iPod mini</b>
	20 Before You Begin
	21 Using the iPod mini Menus
	21 Playing Songs
	22 Using the Other Controls
	22 Disabling the iPod mini Controls Using the Hold Switch
	23 Turning iPod mini On and Off
	23 Using the Backlight
	23 Once You Have Learned to Play Music on iPod mini
<b>Chapter 4</b>	<b>24 Lesson 4: Using iPod mini as a Hard Disk</b>
	24 Before You Begin
	25 Using iPod mini as a Hard Disk
	25 Disconnecting iPod mini

<b>Chapter 5</b>	<b>27 Lesson 5: Managing Music on iPod mini</b>
	27 Before You Begin
	27 Transferring Music to iPod mini
	28 Updating iPod mini Automatically
	28 Updating iPod mini Automatically With Selected Playlists
	29 Updating iPod mini Manually
	29 Next Steps
<b>Chapter 6</b>	<b>30 Learning More About Your iPod mini</b>
	30 iPod mini User's Guide
	30 iTunes Onscreen Help
	30 Online Resources

# iPod mini and iTunes at a Glance

With your new iPod mini digital music player, you can take your music collection with you wherever you go.

You use iPod mini by importing songs from your CD collection to the iTunes music application on your computer, then transferring them to iPod mini for playing on the go. You can also buy music online using the iTunes Music Store (currently available only in the United States).

If you are new to iPod mini or iTunes and want to learn how to get started playing music on iPod mini quickly, this tutorial is for you.

## How to Use the Tutorial

This tutorial has five lessons that teach you how to play music on your new iPod mini and use some other iPod mini features. Before starting the lessons, look through this chapter to get a feel for iPod mini and iTunes. You may want to refer back to this chapter as you go through the tutorial lessons.

To get music on your iPod mini quickly, follow the directions in Lessons 1 to 3, starting on page 11. In these lessons, you learn how to get music into iTunes, transfer music from iTunes to iPod mini, and use the iPod mini controls to play music.

To learn how to use iPod mini as a hard disk, so you can store other files from your computer on iPod mini, go through Lesson 4 (see page 24). To learn more advanced ways of transferring and managing your music, go through Lesson 5 (see page 27).

## Before You Begin

Before you start, make sure that you complete the following:

- Install the iPod mini and iTunes software on the iPod mini CD.
- To make it easier to complete the lessons, print this document.
- Be sure your computer and operating system meet the minimum iPod mini system requirements. See the *iPod mini User's Guide* for system requirements.

## *iPod mini*

Use the iPod mini controls to navigate through onscreen menus, play songs, change settings, and view information.

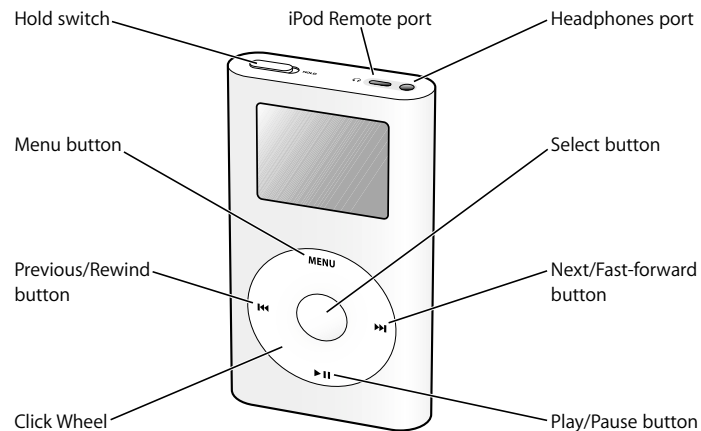

iPod mini Controls	
<b>Hold switch</b>	Use the Hold switch to disable the iPod mini controls, so you don't press buttons accidentally.
<b>iPod remote port</b>	Connect optional accessories, such as the iPod Remote.
<b>Headphones port</b>	Connect headphones and speakers with a standard 3.5 millimeter miniplug.
<b>Menu button</b>	Press to go back to the previous menu. Press and hold to turn on the backlight.
<b>Select button</b>	Press to turn on iPod mini. If iPod mini is on, press to select a menu item or play a song.
<b>Previous/Rewind button</b>	Press to restart the current song. Press twice to play the previous song. Press and hold to rewind.
<b>Next/Fast-forward button</b>	Press to play the next song. Press and hold to fast-forward.
<b>Click Wheel</b>	Run a thumb or finger around the Click Wheel to scroll through menus. From the Now Playing screen, use to control the volume. Press the buttons on the Click Wheel to control iPod mini.
<b>Play/Pause button</b>	Press to play the highlighted song. While a song is playing, press to pause. Press and hold to turn iPod mini off.

## *iPod mini Menu*

When you turn on iPod mini, you see the main menu. Select menu items to go to other menus or perform functions on iPod mini. Status icons along the top of the screen show iPod mini settings.

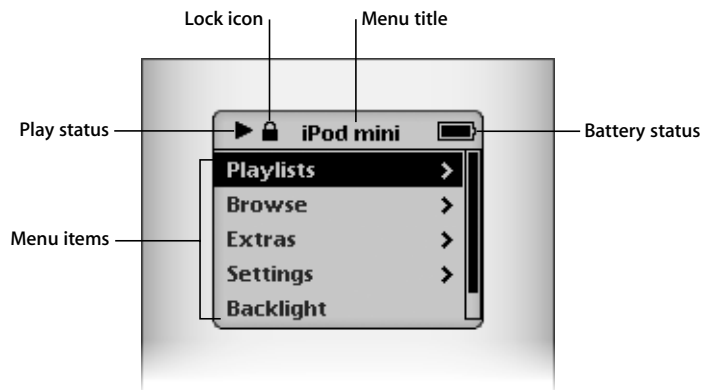

### **iPod mini Menu**

<b>Lock icon</b>	The Lock icon appears when the Hold switch (on top of iPod mini) is set to hold. When the switch is set to hold, the iPod mini controls are disabled.
<b>Menu title</b>	Displays the title of the current menu.
<b>Play status</b>	The Play icon (▶) appears if a song is playing. The Pause icon (⏸) appears if a song is paused.
<b>Battery status</b>	The Battery icon shows the remaining battery charge. If the battery is charging, the icon is animated.
<b>Menu items</b>	Use the Click Wheel to scroll through menu items. Press the Select button (in the center of iPod mini) to select an item. An arrow next to a menu item indicates that selecting it leads to another menu.

## iPod mini Now Playing Screen

When a song is playing, the Now Playing screen appears. When you see the Now Playing screen, you can use the Click Wheel to change the volume. Click the Menu button to go back to the previous menu.

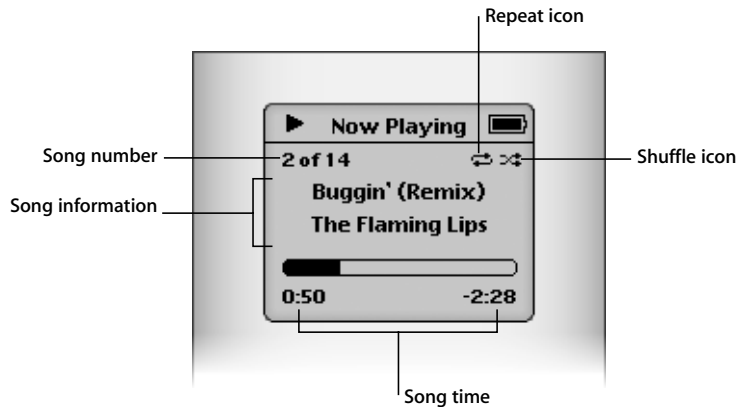

### Now Playing Screen

<b>Song number</b>	Shows the number of the song playing within the current sequence of songs.
<b>Repeat icon</b>	The Repeat icon (↺) appears if iPod mini is set to repeat all songs. The Repeat Once icon (↻) appears if iPod mini is set to repeat one song.
<b>Song information</b>	Displays the song title and the artist.
<b>Shuffle icon</b>	The Shuffle icon (⌘) appears if iPod mini is set to shuffle songs or albums.
<b>Song time</b>	Displays time elapsed and time remaining for the current song. Press the Select button to show the scrubber bar, then use the Click Wheel to scroll to another point in the song.

## iTunes

Use iTunes to import music to your computer and transfer it to iPod mini, organize music on iPod mini, and change settings on iPod mini. You can also use the iTunes Music Store (inside iTunes) to purchase music online. The iTunes Music Store is currently available only in the United States.



### iTunes

<b>Source list</b>	Click items in the Source list to see your music. The Source list shows your library, playlists, CDs, iPod mini, and the iTunes Music Store (currently available only in the United States).
<b>Main window</b>	The main window shows songs from the item selected in the Source list.
<b>Add button</b>	Click to add a playlist to the Source list. Click Library, then drag songs to the playlist to add them.
<b>Options button</b>	Select iPod mini in the Source list, then click this button to change settings on iPod mini.
<b>Eject button</b>	Select iPod mini in the Source list, then click the Eject button to eject iPod mini before disconnecting it from your computer.

# Lesson 1: Getting Music Into iTunes

# 1

To listen to music on your iPod mini, you first need to get that music onto your computer using the iTunes application, then you transfer the music to iPod mini.

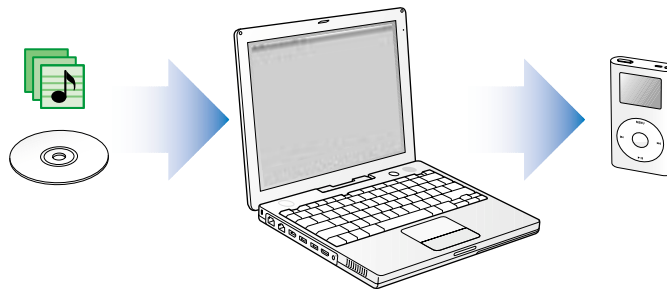

This lesson tells you how to get music into iTunes on your computer. Lesson 2 tells you how to transfer music from your computer to iPod mini.

**There are three ways of getting music into iTunes:**

- Import music from audio CDs
- Buy music online from the iTunes Music Store (currently available only in the United States)
- Add music that's already on your computer to the iTunes music library

## Before You Begin

Before you start, grab some of your favorite audio CDs. Or, if you have an Internet connection, you can purchase music online.

In some tasks shown in this lesson, you will see instructions for choosing iTunes menu commands, which look like this:

Choose File > Get Info.

The first term after Choose is the name of a menu in the iTunes menu bar. The next term is the item you choose from that menu.

## Importing Music From Your Audio CDs Into iTunes

Follow these instructions to get music from your CDs into your computer.

**To import music from an audio CD into iTunes:**

- 1 Insert a CD into your computer and open iTunes.

If you have an Internet connection, iTunes gets the names of the songs on the CD from the Internet and lists them in the window.



*If you are connected to the Internet and iTunes doesn't get the names automatically, choose Advanced > Get CD Track Names.*

*If you don't have an Internet connection, you can enter the names of the songs on the CD manually. Entering song information (or getting it automatically from the Internet) allows you to browse for songs in iTunes or on iPod mini by title, artist, album, and more.*

To enter CD song titles and other information manually:

- a Select the first song on the CD and choose File > Get Info.
  - b Click Info.
  - c Enter the song information.
  - d Click Next to enter information for the next song.
- 2 Click to remove the checkmark next to any songs you don't want to import.
  - 3 Click the Import button. The display area at the top of the iTunes window shows how much time it will take to import each song. By default, iTunes plays songs as they are imported.
  - 4 To eject the CD, click the Eject button.



- 5 Repeat these steps for any other CDs with songs you'd like to import.

## Buying Songs Online Using the iTunes Music Store

If you have an Internet connection, you can easily purchase and download songs, albums, and audiobooks online using the iTunes Music Store (currently available only in the United States).

To purchase music online using the iTunes Music Store, you must set up an Apple Account in iTunes, find the songs you want, then buy them. If you already have an Apple Account, or if you have an America Online (AOL) account, you can use that to sign in to the music store and buy songs.

### To sign in to the iTunes Music Store:

- 1 Open iTunes and click Music Store in the Source list.
- 2 Click the Account button and follow the onscreen instructions to set up an Apple Account or enter your existing Apple Account or AOL account information.

### To find songs or audiobooks:

You can browse or search the iTunes Music Store to find the album, song, or artist you're looking for. Open iTunes and click Music Store in the Source list.

- *To browse the Music Store*, choose a musical genre from the Choose Genre pop-up menu on the top-left side of the store, click one of the albums or songs in the center or right side of the store, or click the Browse button in the top-right corner of the window.
- *To search the Music Store*, type the name of an album, song, artist, or composer in the search field.

- *To search only artist or composer names, or album or song titles*, choose an item from the search field pop-up menu.
- *To search for a combination of items*, choose Power Search from the search field pop-up menu.
- *To return to the front of the Music Store*, click the Home button at the top-left side of the store.

**To buy a song, album, or audiobook:**

- 1 Click Music Store in the Source list, then find the song or album you want to buy.

You can double-click a song to listen to a portion of it and make sure it's the song you want. (If your network connection is slower than 128 kbps, choose iTunes > Preferences, and in the Store pane select the "Load complete preview before playing" checkbox.)

- 2 Click Buy Song or Buy Album.

The song is downloaded to your hard disk and charged to the credit card listed on your Apple or AOL account.

## Adding Songs Already on Your Computer to the iTunes Library

If you have songs on your computer encoded in file formats that iTunes supports, you can easily import the songs into iTunes.

**To add songs on your computer to the iTunes library:**

- Drag the folder or disk containing the audio files to Library in the Source list (or choose File > Add to Library and select the folder or disk). If iTunes supports the song file format, the songs are automatically added to the iTunes library.

You can also drag individual song files to iTunes.

## Once You Have Imported Songs

Once you have your music in iTunes, you can play the songs in iTunes, create playlists, and much more. For more information on using iTunes to manage and play songs, open iTunes and choose Help > iTunes and Music Store Help.

To learn how to transfer music to your iPod mini, read Lesson 2 of this tutorial.

## Lesson 2: Transferring Music to iPod mini

# 2

This lesson tells you how to charge the iPod mini battery, connect iPod mini to your computer, and transfer music from your computer to iPod mini.

### Before You Begin

Before you start, make sure you have each of the following items on hand:

- Your iPod mini and your computer
- The iPod Power Adapter that came with your iPod mini
- The iPod Dock Connector to FireWire Cable that came with your iPod mini

If you have a Windows PC, you'll need to determine which cable to use to connect iPod mini to your computer:

- *If you have a Windows PC with a 6-pin FireWire port, you need the iPod Dock Connector to FireWire Cable that came with your iPod mini (the same cable mentioned above).*



6-pin FireWire 400 port

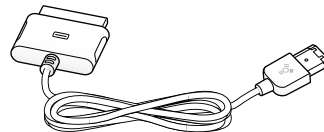

iPod Dock Connector to FireWire Cable

- *If you have a Windows PC with a high-power USB 2.0 port, you'll need the iPod Dock Connector to USB 2.0 Cable that came with your iPod mini.*



USB 2.0 port

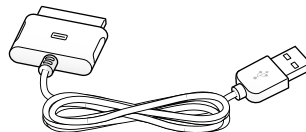

iPod Dock Connector to USB 2.0 Cable

- If you have a Windows PC that doesn't have any FireWire or USB 2.0 ports, you must purchase and install a FireWire or USB 2.0 card. For more information about compatible FireWire and USB 2.0 cards, go to [www.apple.com/ipod](http://www.apple.com/ipod).

## Charging the iPod mini Battery

iPod mini has an internal, nonremovable battery. For best results, charge your iPod mini for at least an hour before you continue this lesson.

### To charge the iPod mini battery:

- 1 Connect the iPod Dock Connector to FireWire Cable to the iPod Power Adapter, and plug the other end of the cable in to iPod mini.
- 2 Plug the power adapter in to a working electrical outlet for at least an hour.

**Note:** If you have a Macintosh, you can also charge the iPod mini battery by connecting iPod mini to your computer. If you have a Windows PC, in most cases you can charge the iPod mini battery by connecting iPod mini to your computer. If the battery is charging, the battery icon on the iPod mini screen animates.

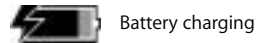

## Connecting iPod mini to Your Computer

You connect iPod mini to your computer to transfer music to iPod mini and organize music on iPod mini.

### To connect iPod mini to your computer:

- 1 Make sure you have the right cable to connect iPod mini to your computer (see "Before You Begin" on page 15). Then connect the cable to a FireWire or USB port on your computer, as shown below.
  - If you have a Macintosh, or if you have a Windows PC with a 6-pin FireWire port:

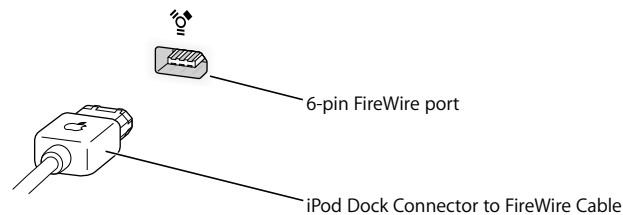

- If you have a Windows PC that doesn't have a 6-pin FireWire port, but has a USB 2.0 port:

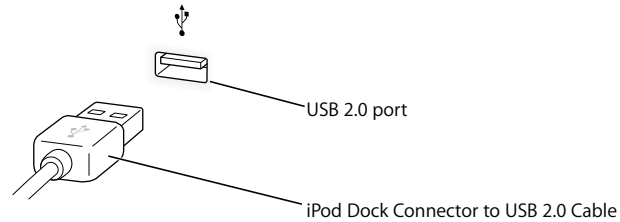

**Note:** Be sure to connect iPod mini to a USB 2.0 port directly on your computer, or to a powered USB 2.0 hub that's connected to your computer. iPod mini won't work if it's connected to a low-power USB 2.0 port, such as those sometimes found on keyboards or other peripherals.

**Note:** If you're using a Windows PC laptop computer with a high-power USB 2.0 port, connect the computer to a power outlet before connecting iPod mini for best results.

- 2 Connect the other end of the cable to iPod mini. Be sure to orient the cable correctly. It only goes in one way.

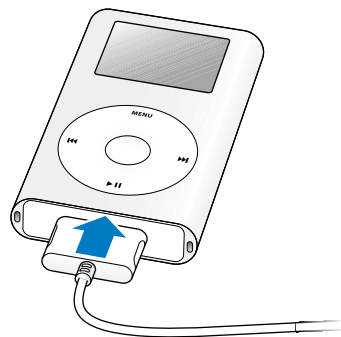

- 3 iTunes may be set to open automatically when you connect iPod mini. If not, open it. You'll see the iPod mini icon show up in the iTunes Source list. If iTunes is set to update your iPod mini automatically (see below), the update begins.

## Transferring Music to iPod mini

By default, iPod mini is set to update automatically with all songs and playlists when you connect it to your computer. This is the simplest way to transfer music to your iPod mini. You just connect iPod mini to your computer, let it add songs automatically, then disconnect it and go.

While music is being transferred from your computer to iPod mini, the iTunes status window shows progress, and the iPod mini icon in iTunes flashes red.



When the transfer is complete, a message in iTunes says “iPod update is complete.”

If there is more music in your iTunes library than can fit on your iPod mini, a dialog appears asking if you want iTunes to choose which songs to transfer. You can also set iTunes to let you update iPod mini manually, so you can drag individual songs to iPod mini and delete individual songs from iPod mini, or you can set iTunes to update iPod mini automatically with only selected songs or playlists.

To learn these ways of transferring music to iPod mini, see “Lesson 5: Managing Music on iPod mini” on page 27.

## Disconnecting iPod mini After Transferring Music

You shouldn't disconnect iPod mini while music is being transferred. You can easily see if it's OK to disconnect iPod mini by looking at the screen.



If you see this message, or if you see the main menu, you can disconnect iPod mini from your computer.

If you set iTunes to let you update iPod mini manually, or if you set iPod mini to be used as a hard disk (see Lesson 4), then you must eject iPod mini before disconnecting it from your computer.



If you see this message, you must eject iPod mini before disconnecting it from your computer.

To eject iPod mini:

- Select iPod mini in the iTunes Source list and click the Eject button.



## Once You Have Transferred Music

Now that you've transferred music to iPod mini and disconnected it from your computer, it's time to get started playing music! To learn how to use the iPod mini controls to play music and change settings, read Lesson 3.

## Lesson 3: Playing Music on iPod mini

# 3

This lesson tells you how to use the iPod mini controls to do things like browse for and play songs, turn iPod mini on and off, turn on the backlight, and change settings.

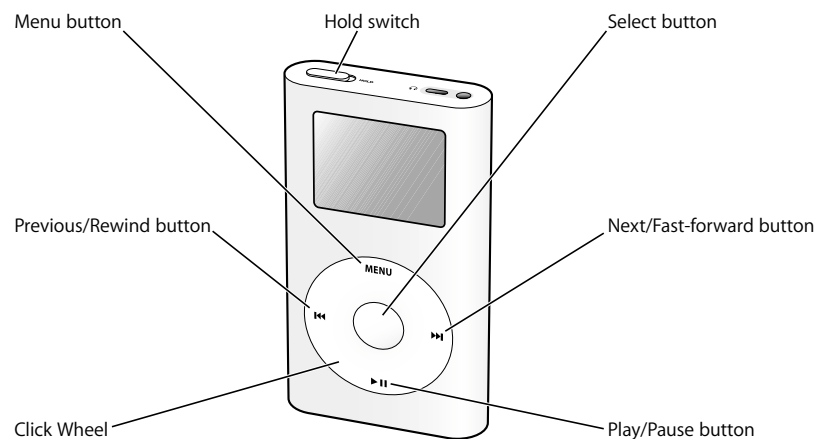

### Before You Begin

If there are no songs on your iPod mini, follow the instructions in Lessons 1 and 2 to transfer music to your iPod mini before you start this lesson.

In some tasks shown in this lesson, you will see instructions for choosing menu commands, which look like this:

Choose Settings > Backlight Timer > 2 Seconds.

The first term after *Choose* is the name of an item in the iPod mini main menu (the first menu you see when you turn on iPod mini). The next item is a choice from the next menu, and so on. If you don't see the first item, press Menu (on the iPod mini Click Wheel) repeatedly until you see the main menu.

## Using the iPod mini Menus

To turn on iPod mini, press the Select button (in the center of iPod mini). When you turn on iPod mini, you see the main menu, entitled “iPod mini.”

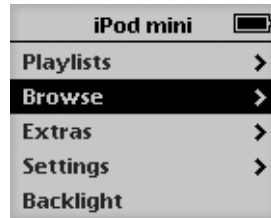

**To select a menu item:**

- 1 Run your finger lightly around the Click Wheel to scroll through menu items.
- 2 Press the Select button to select the highlighted item.

**To go back to the previous menu:**

- Press Menu.

When you select a menu item with an arrow next to it, you move to a new menu.



When you select an item that doesn't have an arrow next to it, you perform an action or change a setting.

## Playing Songs

To get a feel for working with the iPod mini menus, follow the instructions below to browse for and play a song.

**To browse for and play a song:**

- 1 Connect the earphones to your iPod mini and put them on.
- 2 Choose Browse > Song.
- 3 Scroll to a song and press the Play/Pause button or the Select button.

When a song starts playing, you see information about the song in the Now Playing screen.



**To change the volume:**

- If the Now Playing screen is showing, use the Click Wheel to raise or lower the volume.

**Note:** If a song is playing and you don't see the Now Playing screen, wait a few seconds and it will appear, or press Menu repeatedly until you see the main menu, then select Now Playing. Use the Click Wheel to change the volume.

**To move to the next or previous song:**

- Press Next/Fast-forward to move to the next song. Press Previous/Rewind once to move to the beginning of the current song, and twice to move to the previous song.

**To move immediately to another place in the currently playing song:**

- 1 From the Now Playing screen, press the Select button. The progress bar is replaced by a scrubber bar.
- 2 Use the Click Wheel to scroll to another part of the song. After a brief moment, the song jumps to the new position.

## Using the Other Controls

Read the following instructions to learn how to turn iPod mini on and off, turn on the backlight, and use the Hold switch.

### Disabling the iPod mini Controls Using the Hold Switch

If you're carrying iPod mini in your pocket or in a clip case and you don't want to press the buttons or turn it on accidentally, you can make the iPod mini controls inactive.

**To disable the iPod mini controls:**

- Set the Hold switch to hold.



If the iPod mini controls aren't responding, the Hold switch may be set to hold. A Lock icon appears in the top-left corner of the screen.

### Turning iPod mini On and Off

**To turn iPod mini on:**

- Press the Select button.

**To turn iPod mini off:**

- Press and hold Play/Pause.

If no music is playing, iPod mini turns off automatically after a few minutes.

### Using the Backlight

iPod mini has a bright backlight, for low-light conditions.

**To turn on the backlight:**

- Select Backlight from the main menu, or press and hold Menu for a couple of seconds.

**To turn the backlight off:**

- Press and hold Menu again.

### Once You Have Learned to Play Music on iPod mini

Once you've learned to play music on iPod mini, you may want to learn about some other features of iPod mini. To learn about using iPod mini as a hard disk, so you can store files and other data on iPod mini, read Lesson 4. To learn more advanced ways of transferring and managing music, read Lesson 5.

## Lesson 4: Using iPod mini as a Hard Disk

# 4

You can use iPod mini as an external hard disk. That means you can connect it to your computer and copy files from your computer to your iPod mini, or from your iPod mini to your computer.

This can be very useful if you want to move documents or other files from one computer to another, or keep a backup copy of files.



### Before You Begin

To complete tasks in this lesson, you'll connect iPod mini to your computer. To learn how to connect iPod mini to your computer, follow the instructions in Lesson 2 of this tutorial.

## Using iPod mini as a Hard Disk

You use iTunes to set iPod mini to be used as a hard disk.

**To enable iPod mini as a hard disk:**

- 1 Connect iPod mini to your computer and open iTunes.
- 2 Select iPod mini in the iTunes Source list and click the Options button.



- 3 Select "Enable disk use."

**Note:** Selecting "Manually manage songs and playlists" in the Options window also enables iPod mini to be used as a hard disk.

When you use iPod mini as a hard disk, the iPod mini disk icon appears on the desktop on the Mac, or as the next available drive letter in Windows Explorer on a Windows PC.

**To copy files to iPod mini:**

- Drag them from a folder on your computer (or from the desktop) to iPod mini.

**Note:** Files you store on iPod mini take up space. To see how much space is left on iPod mini, choose Settings > About.

## Disconnecting iPod mini

When using iPod mini as a hard disk, you must eject it before disconnecting it from your computer.

**To eject iPod mini if you're using a Macintosh:**

- Drag the iPod mini icon on the desktop to the Trash.

**To eject iPod mini if you're using a Windows PC:**

- Click the Safely Remove Hardware icon in the Windows system tray and select your iPod mini.

You can also eject iPod mini by selecting the iPod mini icon in the iTunes Source list and clicking the Eject button.



You can easily see if it's OK to disconnect iPod mini by looking at the screen.



If you see this message, you must eject iPod mini before disconnecting it from your computer.



If you see this message, or if you see the main menu, you can disconnect iPod mini from your computer.

## Lesson 5: Managing Music on iPod mini

# 5

Lesson 2 taught you how to transfer all your music from iTunes to iPod mini automatically. This lesson tells you how to transfer music manually, and how to transfer a selection of songs automatically.

### Before You Begin

To complete tasks in this lesson, you'll need to connect iPod mini to your computer. To learn how to connect iPod mini to your computer, follow the instructions in Lesson 2 of this tutorial.

### Transferring Music to iPod mini

To set how music is transferred from your computer to your iPod mini, you connect iPod mini to your computer, then use the controls in iTunes to change iPod mini settings.

**You can set iTunes to transfer music to your iPod mini in one of three ways:**

- *Automatically update all songs and playlists:* When you connect iPod mini, it is automatically updated to match the songs in the iTunes library. Any other songs on iPod mini are deleted.
- *Automatically update selected playlists:* When you connect iPod mini, it is automatically updated to match the songs in playlists you select in iTunes. Any other songs on iPod mini are deleted.
- *Manually update iPod mini:* When you connect iPod mini, you can drag songs and playlists individually to iPod mini, and delete songs and playlists individually from iPod mini.

## Updating iPod mini Automatically

By default, iPod mini is set to update automatically with all songs and playlists. This is how you transferred music to iPod mini in Lesson 2. If you set iTunes to transfer music manually, you can reset it later to update iPod mini automatically.

### To set iTunes to update iPod mini automatically with all songs and playlists:

- 1 Open iTunes and select iPod mini in the Source list. Then click the Options button.



- 2 Select "Automatically update all songs and playlists."

The transfer begins automatically.

If there is more music in your iTunes library than will fit on your iPod mini, a dialog appears asking if you want iTunes to choose which songs to transfer. You can also update iPod with only selected playlists, or transfer individual songs and playlists manually (see below).

## Updating iPod mini Automatically With Selected Playlists

A playlist is a list of songs you organize in any order you want. You can create playlists with songs to suit specific moods, songs with a certain theme, or your favorite songs.

Setting iTunes to update iPod mini with selected playlists is especially useful if you have more music on your computer than will fit on your iPod mini. You create playlists in iTunes, then set iPod mini to update with only the songs in the playlists you select.

### To create a playlist in iTunes:

- 1 Click the Add button.



- 2 Type a name for the playlist in the Source list.
- 3 Click Library, then drag a song (or other audio file) to the playlist in the Source list. To select multiple songs, hold the Command (⌘) key or Shift key and click.

For more information on working with playlists and using iTunes, open iTunes and choose Help > iTunes and Music Store Help.

**To set iTunes to update iPod mini automatically with selected playlists:**

- 1 Open iTunes and select iPod mini in the Source list. Then click the Options button.



- 2 Select “Automatically update selected playlists only.”
- 3 Select the playlists you want.

### Updating iPod mini Manually

Setting iTunes to let you update iPod mini manually gives you the most flexibility for managing music on your iPod mini. You can add and delete songs individually. Also, you can add songs from multiple computers to your iPod mini.

**To set iTunes to let you manage songs on iPod mini manually:**

- 1 Open iTunes and select iPod mini in the Source list. Then click the Options button.



- 2 Select “Manually manage songs and playlists.”

**To add a song to iPod mini:**

- Click Library and drag the song to the iPod mini icon in the Source list.

**To delete a song from iPod mini:**

- 1 Click the iPod mini icon in the Source list.
  - 2 Select a song on iPod mini and press the Delete or Backspace key on your keyboard.
- When you delete a song from iPod mini manually, the song is not deleted from your iTunes library.

### Next Steps

Now that you’ve finished this tutorial, you may want to learn more about using iPod mini and iTunes. See Chapter 6 for a list of resources.

# Learning More About Your iPod mini

# 6

If you finish the tutorial and would like to learn more about using your iPod mini and iTunes, there is more information on your computer and on the web.

## iPod mini User's Guide

The *iPod mini User's Guide* that came with your iPod mini is also included as a file on the iPod mini CD.

## iTunes Onscreen Help

To learn more about using iTunes:

- Open iTunes and choose Help > iTunes and Music Store Help.

## Online Resources

- For the latest information on iPod mini, go to [www.apple.com/ipod](http://www.apple.com/ipod).
- To register iPod mini (if you didn't do it when you installed software from the iPod mini CD), go to [www.apple.com/register](http://www.apple.com/register).
- For iPod mini service and support information, a variety of forums with product-specific information and feedback, and the latest Apple software downloads, go to [www.apple.com/support/ipod](http://www.apple.com/support/ipod).
- For support outside of the United States, go to [www.apple.com/support](http://www.apple.com/support) and choose your country from the pop-up menu.
- For an onscreen web-based iTunes tutorial (available in some countries only), go to [www.apple.com/support/itunes](http://www.apple.com/support/itunes).

## iPod mini Software 1.0 Read Me

### About iPod mini Software 1.0

Everything you love about iPod just got tinier! iPod mini lets you bring 1,000 songs everywhere you go in an anodized aluminum body about the size of a business card. Available in five brilliant colors, iPod mini lets you carry three days' worth of music—including all your recent purchases from the iTunes Music Store—when you're walking around town, working out at the gym, commuting to work, riding in the car, going on vacation, dancing around your living room, and going anywhere else you can imagine. Music has never looked so good!

iPod mini software 1.0 is compatible only with iPod mini.

For more information about iPod mini, go to [www.apple.com/support/ipod](http://www.apple.com/support/ipod).

For more information about iTunes and the iTunes Music Store, go to [www.apple.com/itunes](http://www.apple.com/itunes).

For more information about iPod accessories, go to [www.apple.com/ipod](http://www.apple.com/ipod).

### System Requirements

- \* A PC with built-in FireWire or USB 2.0, or a FireWire or USB 2.0 card
- \* Windows 2000 Service Pack 4 or later, or Windows XP Home or Professional

### iPod mini Software and Other iPod Models

iPod mini software is not compatible with other models of iPod, including original scroll wheel and touch wheel iPods and iPods with a dock connector. The iPod mini 1.0 Updater will not update or restore other models of iPod.

Some versions of iTunes may mistakenly offer to update your other iPod with iPod mini software. If this happens, agree to let it try. The updater will notice the incompatibility and fix the installation so that the wrong updater will no longer be offered as a choice for updating other iPods.

©2004 Apple Computer, Inc. All rights reserved.

Apple, the Apple logo, FireWire, and iTunes are trademarks of Apple Computer, Inc., registered in the U.S. and other countries. iPod is a trademark of Apple Computer, Inc.

Updated February 1, 2004